



Thin Film Products
Components
Complete Product Catalogue

SUSUMU CO., LTD.

On Environment

You are making "Ecologically Sound" decisions by using Susumu products!

- The Thin Film deposition process requires minimal amounts of raw materials.
Thin Film resistors are manufactured by processes that utilize minimal amounts of raw materials.
- Our processes use less electricity and emit less CO2.
Number of heating, curing and sintering process are minimized. When heat is required, We use temperature as low as possible.
- Our products are extremely small :using fewer of the earth's natural resources.
Even though they are small, their precision performance is unmatched.
- Using Susumu's products means reducing your products' environmental load.
By using Susumu's products, you are contributing to a healthy environment.

Susumu's thin film products are environmentally friendly.

- All Susumu's products are RoHS compliant.
- Almost all products are halogen-free correspondence products.

■ The following logos designate "greenness" of the products.



■ About REACH

REACH was established by the European Chemical Agency (ECHA) in 2007 in order to manage the risk that chemicals pose to health and the environment. REACH stands for

Registration, Evaluation, and Authorization of Chemicals.

For the latest information on the SVHC list under REACH regulations, please visit our website.



Weight ratio (%) for each structural part of typical thin film chip resistors

Product series (Structural part)	RG1005	RG1608 URG1608	RG2012 URG2012	RG3216 URG3216	PRG3216	PRG6432	RM2012	RM3216	RoHS compliance **
Ceramic substrate	83.18	86.95	87.63	89.51	89.36	92.26	87.78	92.86	●
Resistive element	0.02	0.02	0.02	0.02	0.02	0.11	0.02	0.02	●
Terminal: bottom layer	0.16	0.13	0.11	0.15	0.15	0.11	0.15	0.10	●
Terminal: middle layer	8.33	5.82	5.58	4.83	4.82	3.49	5.87	2.96	●
Terminal: outer layer	5.45	3.81	3.65	3.16	3.15	2.28	3.84	1.94	●
Protective coating	A								●
	B	2.87	2.93	2.67	2.06	2.22	1.79	1.99	●
	C								●
Marking ink		0.34	0.36	0.28	0.28	0.07	0.37	0.25	●
Total weight (mg)	0.72	2.07	4.12	8.26	8.27	30.81	4.11	7.96	●

*1 Contact our sales office regarding the composition of restricted or hazardous materials.

The long life of Susumu products means effective usage of natural resources.

■ URG series

IP.11

■ RG series

IP.15

The RG series, with its inorganic passivation, realizes less than +/-0.25% drift after 10000 hour stress tests. The ultra reliable URG series also uses inorganic passivation technology and attains less than +/-0.02% drift after similar stress tests.

Small sizes and high power handling capability also mean effective usage of natural resources.

■ PRG series

IP.25

■ HRG series

IP.29

Size	Rated power (W)		Power ratio
	RG series	PRG series	
2012 / 2010	1/8	1/2	4 times
3216	1/4	1	4 times

Size	Rated power (W)		Power ratio
	RG series	HRG series	
3216	1/4	1	4 times

Susumu, together with its group companies, is striving to manufacture environmentally friendly and high quality products.

○ Susumu group companies' ISO14001 certification status

Company names	facility location	Certification date	Valid date	Certification body	Certification No.
Susumu Co. Ltd	Obama, Japan	2000.12.15	2021.12.14	JQA	EM1184
	Kyoto Headquarters, and other sales offices				
	Niigata, Japan	2001.03.09	2021.12.14	JQA	EM1184
Susumu(Suzhou) Co., Ltd.	Suzhou (China)	2015.09.23	2021.09.21	TIRT	04818E40280R1M
Cyntec	Hsin-Chu (Taiwan)	2002.08.26	2020.06.20	DQS	20000618 UM15
	Suzhou (China)	2003.10.22	2020.06.20	DQS	20000617 UM15

○ Susumu group companies' ISO9001 certification status

Company names	facility location	Certification date	Valid date	Certification body	Certification No.
Susumu Co. Ltd	Obama, Japan	1998.11.06	2021.03.13	JQA	JQA2755
	Kyoto Headquarters, and other sales offices				
	Niigata, Japan	1988.07.23	2021.03.13	JQA	JQA2755
Susumu(Suzhou) Co., Ltd.	Suzhou (China)	2011.05.01	2021.05.08	BUREAU VERITAS	CNB312728-UK
Cyntec	Hsin-Chu (Taiwan)	1997.03.06	2021.04.01	DQS	20000618 QM15
	Suzhou (China)	1997.03.06	2021.04.01	DQS	20000617 QM15

○ Susumu group companies' IATF 16949 certification status

Company names	facility location	Certification date	Valid date	Certification body	Certification No.
Susumu Co. Ltd	Obama, Japan	2004.11.12	2021.02.20	JQA	JQA-AU0068-1(IATF:0291268)
	Kyoto Headquarters, and other sales offices				
	Niigata, Japan	2015.10.01	2021.02.20	JQA	JQA-AU0068-2(IATF:0335802)
Susumu(Suzhou) Co., Ltd.	Suzhou (China)	2011.05.02	2021.04.23	BUREAU VERITAS	CHN-19878/TS(IATF:301653)
Cyntec	Hsin-Chu (Taiwan)	2007.04.24	2021.04.01	DQS	0297408
	Suzhou (China)	2007.04.24	2021.04.01	DQS	0297419

Table of Contents

Susumu and the Environment	01
Products list	03
Selection Guide	05
In order for customers to choose the best parts for their requirements, the following pages contain tables that provide an outline for each product series. For details, please refer to the specification pages or contact our sales office.	
Table for E series resistant values; table for 3 letter designation of E96 resistive value	07
Handling care for our products.	08
Products specifications	10
Thin film surface mount resistors	
Resistors with radial leads	
Current sensing surface mount resistors	
Power choke coils	
High frequency surface mount components	
Sample kits	
Standard specification	98
International sales offices	113

Products categories

Product group	Product category	Series	Power ratings (W)													Resistance tolerance (%)						Environmental compliance ^{*2}	Specification pages				
			3	2	1.5	1	3/4	1/2	1/3	1/4	1/5	1/8	1/10	1/16	1/20	1/32	±0.01	±0.02	±0.05	±0.1	±0.5			±1	±20		
Thin film surface mount resistors	Metal thin film chip resistors (the highest reliability and precision)	URG					●	●		●			●	●				●	●	●	●	●		●	11-14		
	Metal thin film chip resistors (the highest precision)	RG							●			●	●	●		●			●	●	●			●	15-16		
	Metal thin film chip resistors (wide temperature range)	RGT										●	●	●		●				●	●			●	17-18		
	Metal thin film chip resistors (high voltage operation)	RGV							●	●										●	●			●	19-20		
	Non-magnetic thin film chip resistors	NRG								●		●	●	●					●	●	●			●	21-22		
	Audio thin film chip resistors (high precision)	RS														●	●			●	●			●	23-24		
	High power thin film chip resistors (long side terminal)	PRG	●	●	●	●														●	●			●	25-28		
	High power thin film chip resistors (short side terminal)	HRG				●															●	●			●	29-30	
	Anti-surge thin film chip resistors	MRG						●		●		●	●								●	●			●	31-32	
	High temperature thin film chip resistors	RGA												●	●		●				●	●			●	33-34	
	Metal thin film chip resistors (precision)	RR												●	●	●					●	●	●		●	35	
	Metal thin film trimmable chip resistors	RT												●	●	●								●	●	36	
	Metal thin film chip resistor networks	RM											●	●						● ^{*1}	● ^{*1}	●	●	●		●	37-44
	High temperature metal thin film resistor networks	RMA									●	●	●							● ^{*1}	● ^{*1}	●	●	●		●	45-46

Product group	Product category	Series	Power ratings (W)													Resistance tolerance (%)							*2 Environmental compliance	Specification pages			
			3	2	1.5	1	3/4	1/2	0.3	1/4	1/5	1/8	1/10	1/16	1/20	1/32	±0.01	±0.02	±0.05	±0.1	±0.25	±0.5			±1	±20	
Resistors with radial leads	Radial lead metal thin film chip resistors (the highest reliability and precision)	LRG							●									●	●	●	●					●	49-50

Product group	Product category	Series	Power ratings (W)													Resistance tolerance (%)					*2 Environmental compliance	Specification pages					
			10	8	6	5	4	3	2	1.5	1	3/4	2/3	1/2	1/3	1/4	1/5	1/6	1/8	±0.5			±1	±2	±5		
Current sensing surface mount resistors	Metal foil low resistance chip resistors (long-side terminal)	KRL	●		●	●	●	●	●	●			●						●	●	●	●				●	53-54
	Metal foil low resistance chip resistors (short-side terminal)	KRL				●			●	●		●	●	●				●		●	●	●				●	55-56
	Metal foil low resistance chip resistors (4 terminal type)	KRL				●	●	●	●		●									●	●	●	●			●	57-58
	Precision low resistance chip resistors	SHR											●						●							●	59-60
	Low resistance chip resistors (long-side terminal)	PRL/RL							●		●		●		●				●	●	●	●				● ^{*3}	61-62
	Low resistance chip resistors (short-side terminal)	RL											●	●	●	●	●	●		●	●	●	●			● ^{*3}	63-64
	High Current chip jumpers	YJP																								●	65

Product group	Product category	Series	Inductance (μH)							Rated current (A)						*2 Environmental compliance	Specification pages									
			0.1 ~ 0.49	0.5 ~ 0.99	1.0 ~ 2.9	3.0 ~ 4.9	5.0 ~ 9.9	10 ~	0.45 ~ 0.9	1.0 ~ 4.9	5.0 ~ 9.9	10 ~ 19.9	20.0 ~ 34.9	35.0 ~												
Power choke coils	Power choke coils	PCMB	●	●	●	●	●	●	●	●	●	●	●	●	●	●	●	●	●	●	●	●	●	●	●	69
	Small power choke coils	PCMB /PS	●	●	●	●	●	●	●	●	●	●	●	●	●	●	●	●	●	●	●	●	●	●	●	70

Product group	Product category	Series	Attenuation (dB)													Attenuation tolerance (dB)					*2 Environmental compliance	Specification pages				
			0	1	2	3	4	5	6	7	8	9	10	16	20	30	20	10	6	3						
High frequency surface mount components	Frequency Chip Attenuator	ATS	●	●	●	●	●	●	●	●	●	●	●	●	●	●	●								●	73-74
	Precision chip attenuators	PAT	●	●	●	●	●	●	●	●	●	●	●	●	●	●	●			●					●	75-78
	Precision chip attenuators (W type)	PAT-W	●	●	●	●	●	●	●	●	●	●	●	●	●	●	●			●	●				●	79-82
	Thermo-variable chip attenuators	P*V	●	●	●	●	●	●	●	●	●	●	●	●	●	●	●			●	●				●	83-86

Product group	Product category	Series	Input power ratings (mW)				Frequency range (DC ~ X GHz)				*2 Environmental compliance	Specification pages													
			500	250	125	100	20	17.5	15	10															
High frequency surface mount components	Chip power splitter	PS	●	●	●	●	●	●	●	●	●	●	●	●	●	●	●	●	●	●	●	●	●	●	87-88

Product group	Product category	Series	Power ratings (W)										Frequency range (DC ~ X GHz)						*2 Environmental compliance	Specification pages						
			100	60	30	20	10	5	2.5	2	1	0.5	0.2	15	12.5	10	7.5	5			3					
High frequency surface mount components	High power thin film chip terminator	PCS/HPT	●	●	●	●	●	●	●	●	●	●	●	●	●	●	●	●	●	●	●	●	●	●	●	89-92

*1 Relative tolerance
 *2 Environmental compliance: EU-RoHS, REACH SVHCxx, Completely Pb free, Halogen free
 *3 RoHS compliant but resistive element contains few ppm level lead. Not completely lead free.

Selection Guide

The RG series, the most popular metal thin film chip resistors because of their high precision, high reliability and long-term stability, is the base of our line-up of new innovative products: a higher precision, higher operating temperature, higher power handling capability, higher anti-surge capability version of the RG series and so on.

All of these products employ the inorganic passivation technology that enables high precision and high reliability. In addition, our thin film based terminal technology does not involve any Ag (silver) and they are sulfur impervious. The following diagram shows distinctive characteristics of these products and their relationships.

- Higher precision : URG series, LRG series (with radial leads)
- Higher operating temperature : RGT series, RGA series, RMA series (resistive networks)
- High voltage: RGV series
- High power : PRG series (long side terminal), HRG series (short side terminal)
- Anti-surge : MRG series
- Non-magnetic : NRG series
- Audio grade : RS series

Relation map of thin film chip resistors

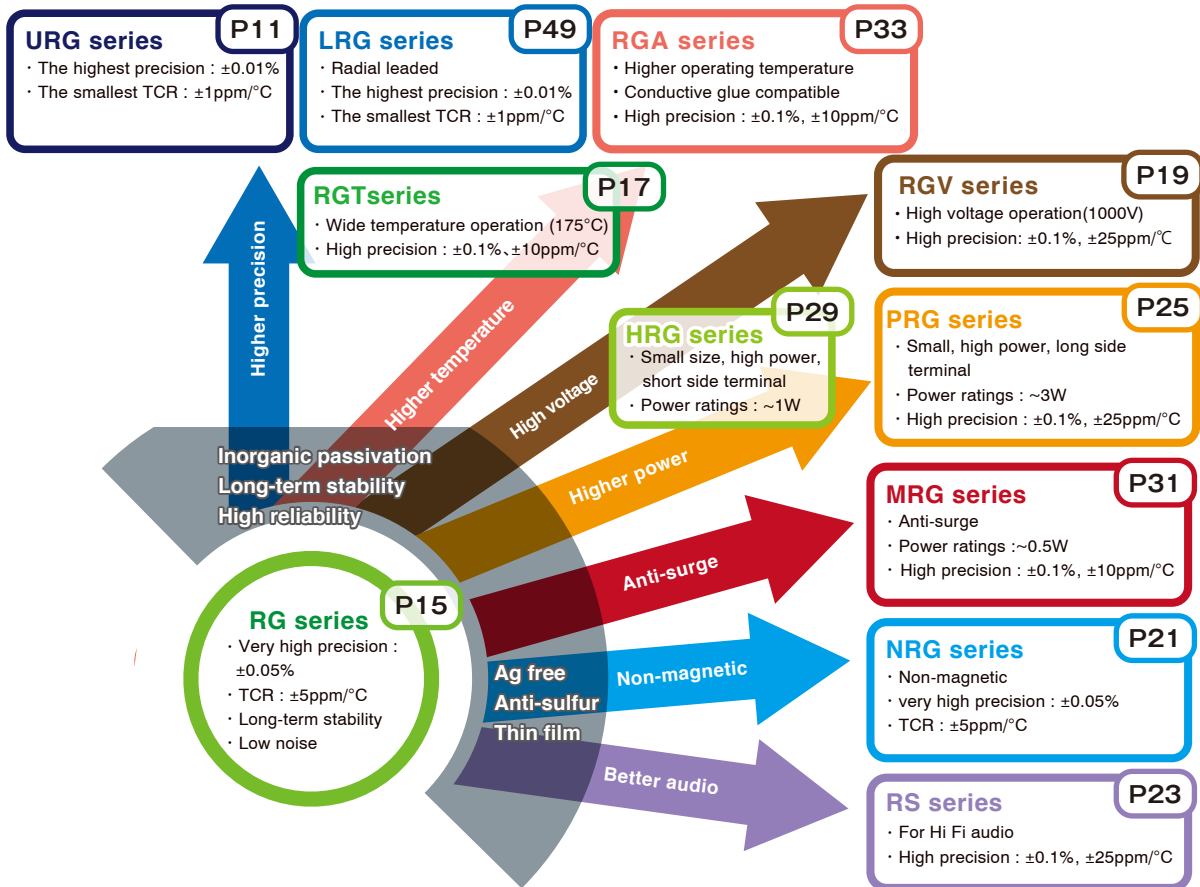

Map from discreet RG series to resistor networks

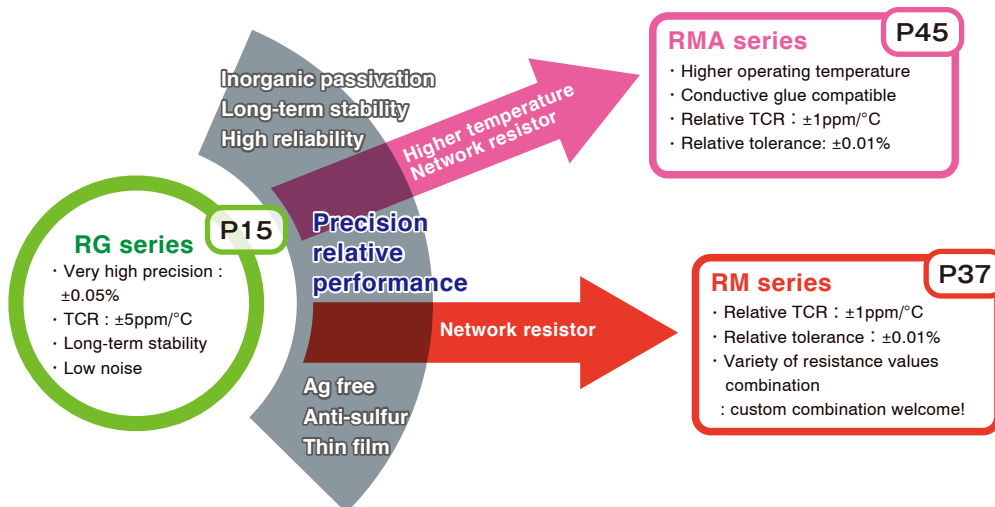

Thin film resistor map by performance

Thin film resistors are highly reliable and stable over long periods of time. The diagrams below show the matrix of Susumu's thin film resistors based on tolerance with TCR, and tolerance with power ratings.

The high power resistors are offered in two different terminal configurations; PRG series -long side terminal and HRG series - short side terminal, to meet your need for miniaturization using same power.

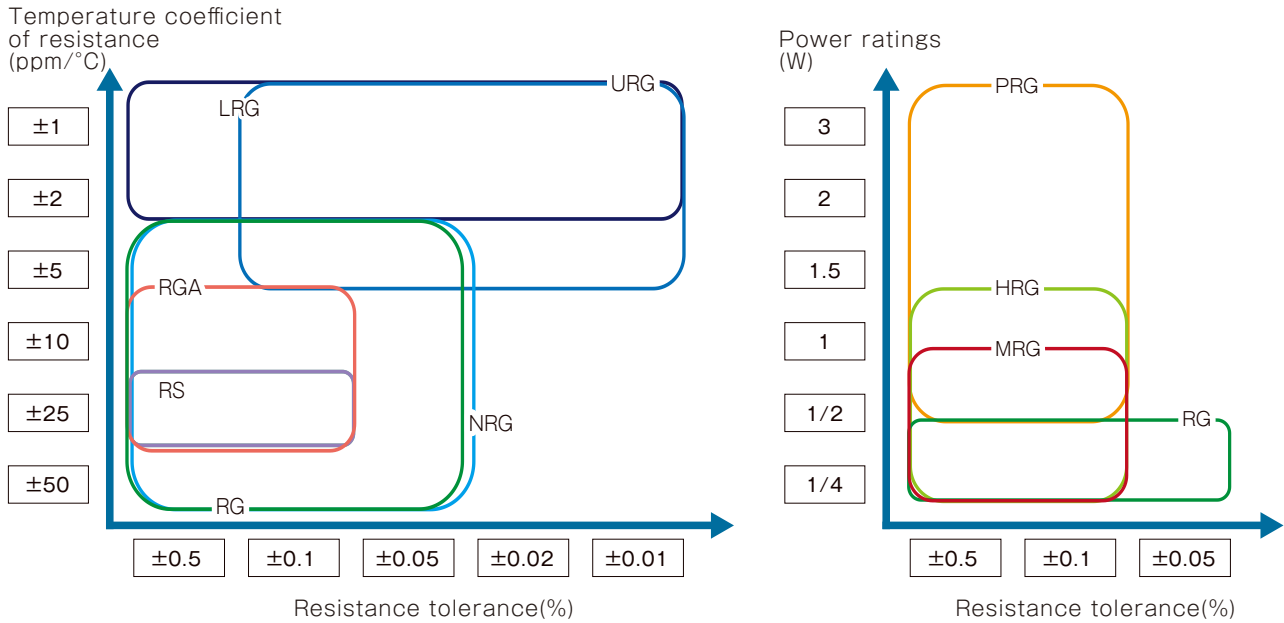

Current sensing chip resistors' relation map

The diagram below illustrates how we expanded our current sensing chip resistors in order to meet the need for miniaturization and high power ratings.

We also offer 4 terminal current sensor isolating voltage terminals, making it easier to mount on the board. We will continue to expand current sensing chip resistor series corresponding the needs of the market.

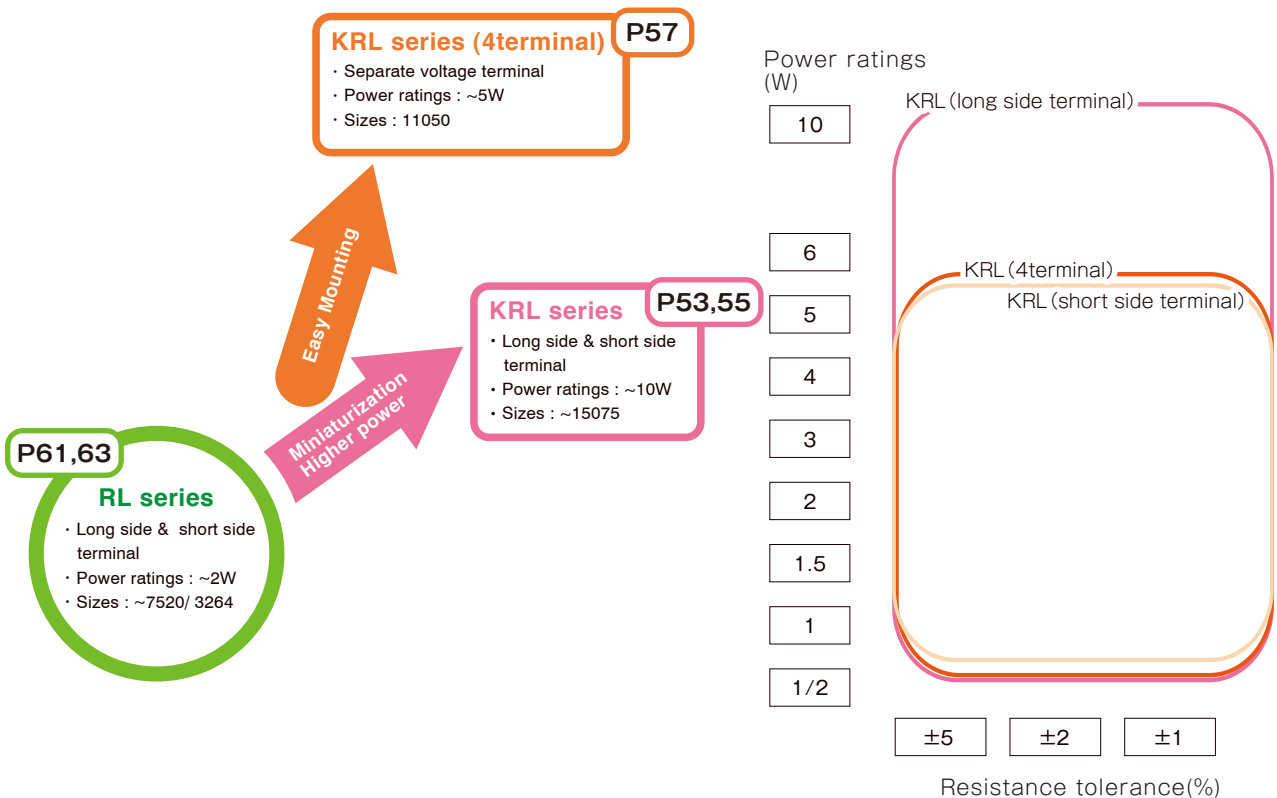

E series resistance values (IEC designated series of resistance values)

series	Values															
E-6	1.0	1.5	2.2	3.3	4.7	6.8										
E-12	1.0	1.2	1.5	1.8	2.2	2.7	3.3	3.9	4.7	5.6	6.8	8.2				
E-24	1.0	1.1	1.2	1.3	1.5	1.6	1.8	2.0	2.2	2.4	2.7	3.0	3.3	3.6	3.9	
	4.3	4.7	5.1	5.6	6.2	6.8	7.5	8.2	9.1							
E-96	1.00	1.02	1.05	1.07	1.10	1.13	1.15	1.18	1.21	1.24	1.27	1.30	1.33	1.37	1.40	
	1.43	1.47	1.50	1.54	1.58	1.62	1.65	1.69	1.74	1.78	1.82	1.87	1.91	1.96	2.00	
	2.05	2.10	2.15	2.21	2.26	2.32	2.37	2.43	2.49	2.55	2.61	2.67	2.74	2.80	2.87	
	2.94	3.01	3.09	3.16	3.24	3.32	3.40	3.48	3.57	3.65	3.74	3.83	3.92	4.02	4.12	
	4.22	4.32	4.42	4.53	4.64	4.75	4.87	4.99	5.11	5.23	5.36	5.49	5.62	5.76	5.90	
	6.04	6.19	6.34	6.49	6.65	6.81	6.98	7.15	7.32	7.50	7.68	7.87	8.06	8.25	8.45	
	8.66	8.87	9.09	9.31	9.53	9.76										

Three-letter codes for resistance value (Codes for Marking in E96 series)

- (1) A manufacturing date code: Refer to JIS C 5201-1.
- (2) Three digits of number shall be marked on the protective coating. In this case, the three digits of code number shall be added at the end of type designation.

(Example) 4.99KΩ = 499 × 10¹

Marking: 68H
Type designation: RR0816P-4991-D-68H

code for power of 10

code	E96 value	code	E96 value	code	E96 value	code	E96 value	code	E96 value	code	E96 value	code	E96 value	code	E96 value
01	100*	13	133	25	178	37	237	49	316	61	422	73	562	85	750*
02	102	14	137	26	182	38	243	50	324	62	432	74	576	86	768
03	105	15	140	27	187	39	249	51	332	63	442	75	590	87	787
04	107	16	143	28	191	40	255	52	340	64	453	76	604	88	806
05	110*	17	147	29	196	41	261	53	348	65	464	77	619	89	825
06	113	18	150*	30	200*	42	267	54	357	66	475	78	634	90	845
07	115	19	154	31	205	43	274	55	365	67	487	79	649	91	866
08	118	20	158	32	210	44	280	56	374	68	499	80	665	92	887
09	121	21	162	33	215	45	287	57	383	69	511	81	681	93	909
10	124	22	165	34	221	46	294	58	392	70	523	82	698	94	931
11	127	23	169	35	226	47	301	59	402	71	536	83	715	95	953
12	130*	24	174	36	232	48	309	60	412	72	549	84	732	96	976

code	power
A	10 ⁰
H	10 ¹
C	10 ²
D	10 ³
E	10 ⁴
F	10 ⁵
R	10 ⁻¹
S	10 ⁻²

* The resistance value duplicated in E24 series and in E96 series shall be manufactured in E24 series only.

Disclaimer and handling care of our products

Disclaimer

1. The contents of this catalogue are only for reference purposes and its contents may be changed without prior notification. Official specifications will be submitted to each customer. For ordering, please contact our sales representatives
2. The products listed in this catalogue are for general purpose electronic equipment. Please consult with us if you require specific qualities or reliability as in nuclear or aerospace applications.
3. When you incorporate our products in your design, please utilize them within their specified operating conditions such as rated power and recommended operating temperature. We cannot guarantee our products and cannot take responsibility for the failure of our products if they are used under improper conditions or outside of the parameters of our specified conditions.
4. No part of this publication may be reproduced by any means without the permission of Susumu Co. Ltd.

Handling and care

< Consideration during mounting >

- (1) Before, during and after mounting, take care not to damage the protective coating of the products. Damage to the protective coating may result in weakening the humidity tolerance.
- (2) When using a soldering iron, the heat should be applied to the land pattern not directly to the component. The tip of the soldering iron should not touch the resistors directly. In addition, when the tip of the soldering iron is hot, please do soldering as quick as possible (Below 350°C within 3 seconds).
- (3) Flux residue can cause corrosion and electro-migration resulting in the deterioration of humidity tolerance. If you utilize highly activated flux, such as flux containing chlorine, please consult with us prior to usage.
- (4) Ionized foreign material contamination or residue can also cause corrosion and electro-migration resulting in the deterioration of humidity tolerance. Do not touch the components with bare hands prior to or after mounting.
- (5) If the soldering operation takes place at very high temperatures and for a prolonged period of time, the terminal may dissolve into the solder.
- (6) When mounted components are embedded into resin or polymer, the resin/polymer selection must consider heat tolerance, humidity tolerance, mechanical properties, and chemical or ion composition.

< Operating environment; condition >

- (1) If these components are utilized for unusual conditions, the reliability and characteristics should be verified in advance. Such conditions include:
 - ① Exposure of the component to water, salt water, oils, acids, alkaline, or solvents
 - ② Exposure of the component to direct sunlight, outdoor weather conditions, or heavy dust
 - ③ Exposure to frost
 - ④ Possible exposure to corrosive air or gas such as a marine atmosphere, HCl, Cl₂, H₂S, NH₃, SO₂, and NO_x.
- (2) Usage under high temperatures and high humidity
 - ① When components are used under high temperature conditions, assess the potential temperatures surrounding the components considering the other heat-producing neighboring components, and regulate your power usage following the specified derating curve.
 - ② If the components are used under high humidity conditions or at temperatures below the dew point, the products can experience positive resistance drift or even an open circuit.
- (3) Use our products under the rated power when the pulse current or voltage is applied. The peak voltage of the pulse should remain under the rated voltage.

Thin film surface mount resistors

Metal thin film chip resistors

(the highest reliability and precision)

URG series

Metal thin film chip resistors

(the highest precision)

RG series

Metal thin film chip resistors

(wide temperature range)

RGT series ★New series

Metal thin film chip resistors

(high voltage operation)

RGV series ★New series

Non-magnetic metal thin film chip resistors

NRG series

Audio thin film chip resistors

(high precision)

RS series

High power thin film chip resistors

(long side terminal)

PRG series

High power thin film chip resistors

(short side terminal)

HRG series

Anti-surge thin film chip resistors

MRG series

High temperature thin film chip resistors

RGA series

Metal thin film chip resistors

(precision)

RR series

Metal thin film trimmable chip resistors

RT series

Metal thin film chip resistor networks

RM series

High temperature metal thin film resistor networks

RMA series

Metal thin film chip resistors (the highest reliability and precision)

■ URG series

AEC-Q200 Compliant

Features

- The tightest resistance tolerance: +/-0.01%
- The smallest temperature coefficient of resistance: ±1ppm/°C
- Long term stability with inorganic passivation
- Thin film structure enabling low noise and anti-sulfur

Applications

- Industrial measurement, electrical scales
- High precision sensors, medical electronics



Thin film surface mount resistors



URG series

◆ Part numbering system

URG 2012 L - 102 - L - T1

Series code

Size: URG1608, URG2012,
URG3216, URG5025, URG6432

Temperature coefficient of resistance

Packaging quantity: T1(1,000pcs),
T05(500pcs), T01(100pcs)

Resistance tolerance

Nominal resistance value (E-24: 3 digit, E-96: 4 digit,
URG3216, URG5025, URG6432: all 4 digit)

◆ Electrical Specification

Type	Power ratings	Temperature coefficient of resistance	Resistance range(Ω) Resistance tolerance					Maximum voltage	Resistance value series	Operating temperature	Packaging quantity
			±0.01% (L)	±0.02% (P)	±0.05% (W)	±0.1% (B)	±0.5% (D)				
URG1608	1/16W	±1(K) *1	250 ≤R ≤7.5K	100 ≤R ≤7.5k			100V	E24, E96	-55°C ~ 155°C	T1	
		±2(L) *2									
URG2012	1/10W	±1(K) *1	250 ≤R ≤36K	100 ≤R ≤36k			150V	E24, E96	-55°C ~ 155°C	T1	
		±2(L) *2									
URG3216	1/4W	±1(K) *1	250 ≤R ≤68K	100 ≤R ≤68k			200V	E24, E96	-55°C ~ 155°C	T05	
		±2(L) *2									
URG5025	1/2W	±1(K) *1	250 ≤R ≤100K	100 ≤R ≤150k			300V	E24, E96	-55°C ~ 155°C	T01	
		±2(L) *2									
URG6432	3/4W	±1(K) *1	250 ≤R ≤100K	100 ≤R ≤200k			300V	E24, E96	-55°C ~ 155°C	T01	
		±2(L) *2									

*1: Applicable TCR K (±1.0) at temperature range 25°C~65°C
Applicable TCR K (±1.5) at temperature range -20°C~25°C, 65°C~125°C

*2: Applicable TCR L at temperature range -20°C~125°C

***Contact us for requirements not listed in above table.**

◆ Dimensions

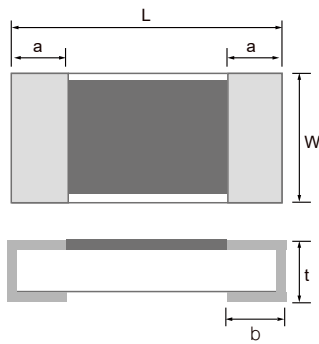

Type	Size (inch)	L	W	a	b	t
URG1608	0603	1.60±0.20	0.80+0.25/-0.20	0.30±0.20	0.30±0.20	0.40+0.15/-0.10
URG2012	0805	2.00±0.20	1.25+0.25/-0.20	0.40±0.20	0.40±0.20	0.40+0.15/-0.10
URG3216	1206	3.20±0.20	1.60±0.25	0.50±0.25	0.50±0.20	0.40+0.15/-0.10
URG5025	2010	5.00±0.20	2.50±0.25	0.60±0.25	0.60±0.25	0.45±0.10
URG6432	2512	6.40+0.20/-0.40	3.20±0.25	0.75±0.25	0.80±0.20	0.45±0.20

(unit : mm)

Thin film surface mount resistors

URG series

◆ Reliability specification

Test items	Condition (test methods (MIL-PRF-55342/JIS C5201-1))	Standard
Short time overload	2.5 x rated voltage, *1 5seconds	±0.02%+0.01Ω
Life (biased)	70°C, rated voltage, *1 90min on 30min off, 2000hours	±0.02%+0.01Ω(R≥250Ω)
		±0.05%+0.01Ω(R<250Ω)
High temperature high humidity	85°C, 85%RH, 1/10 of rated power, 90min on 30min off, 1000hours	±0.05%+0.01Ω
Temperature shock	-65°C (15min) ~ 150°C (15min) 100cycles	±0.02%+0.01Ω
High temperature exposure	155°C, no bias, 1000hours	±0.05%+0.01Ω
Resistance to soldering heat	235±5°C, 30 seconds (reflow), (by MIL-PRF-55342)	±0.01%+0.01Ω

*1 Rated voltage is given by $E = \sqrt{R \times P}$

E= rated voltage (V), R=nominal resistance value(Ω), P=rated power(W)

If rated voltage exceeds maximum voltage /element, maximum voltage/element is the rated voltage.

Metal thin film chip resistors

(the highest reliability and precision)

URG series

Reliability test data

Biased life test

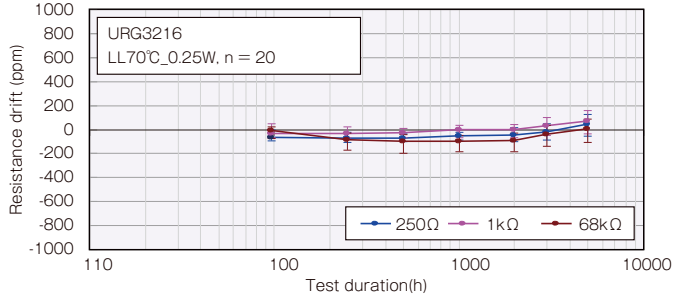
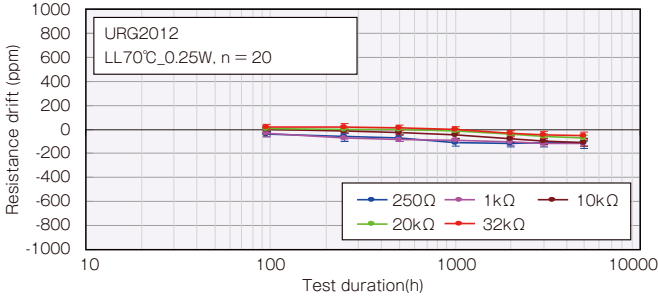

High temperature high humidity (biased)

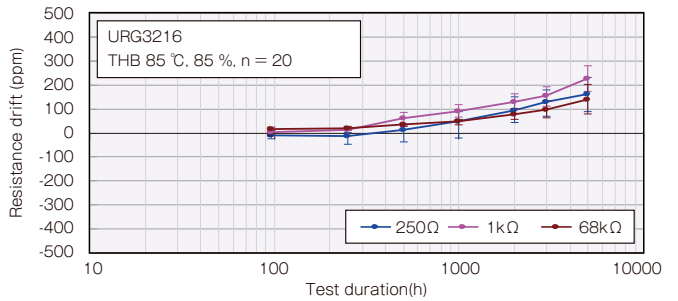
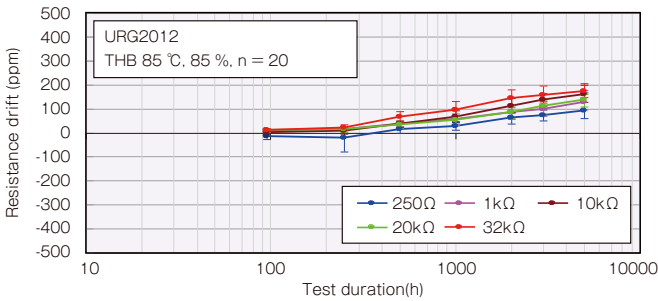

Temperature shock

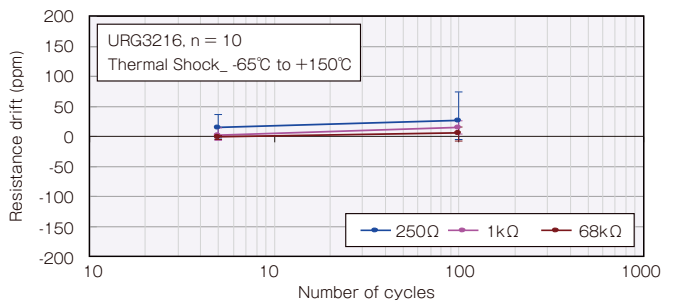
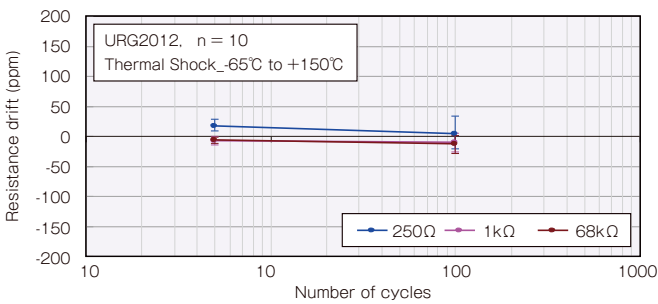

High temperature exposure

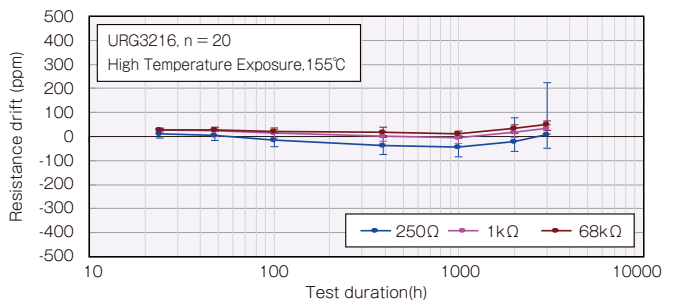
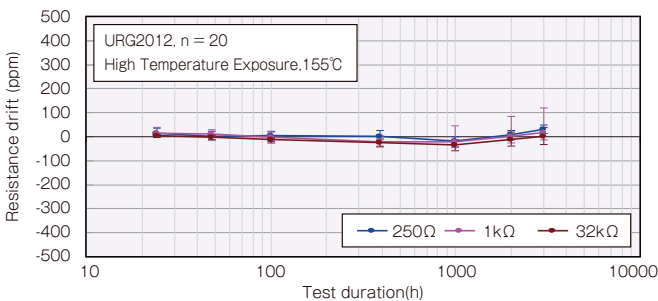

◆ Temperature coefficient of Resistance

○ URG2012

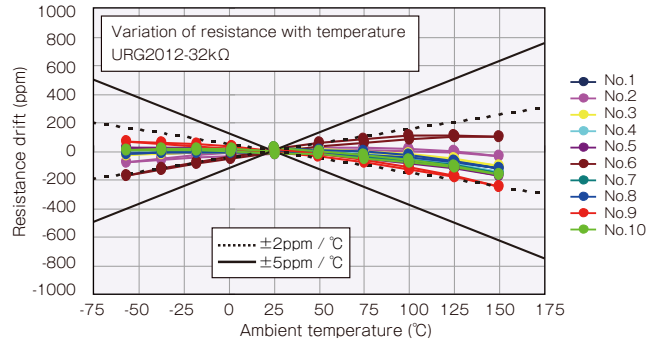
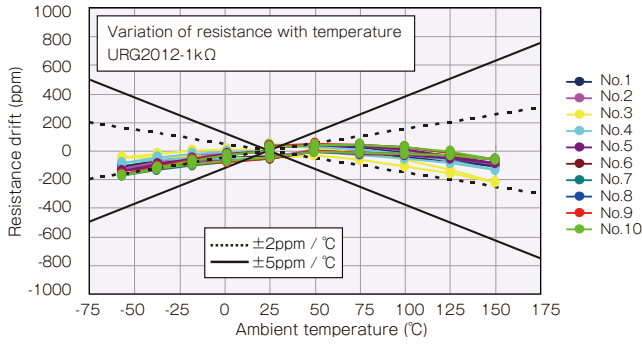

○ URG3216

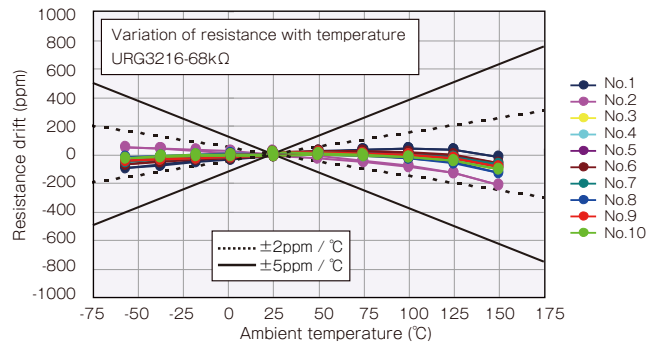
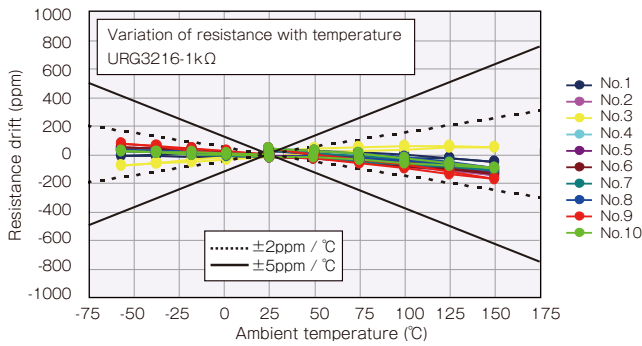

◆ Derating Curve

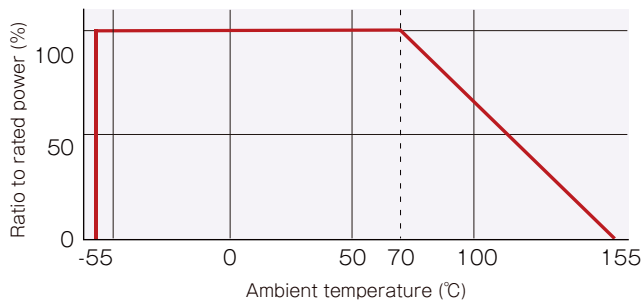

Metal thin film chip resistors (the highest precision)

■ RG series

AEC-Q200 Compliant

Features

- Long term stability with inorganic passivation
- Less than $\pm 0.1\%$ drift after 10000 hours of reliability test
- High precision resistance tolerance: $\pm 0.05\%$, very small TCR: $\pm 5\text{ppm}/^\circ\text{C}$
- Thin film structure enabling low noise and anti-sulfur

Applications

- Automotive electronics
- Industrial measurement instrumentation, industrial machines
- Various sensors, medical electronics



Thin film surface mount resistors



RG series

◆ Part numbering system

RG 1608 N - 102 - B - T5

Series code

Size: RG1005, RG1608, RG2012, RG3216

Temperature coefficient of resistance

Packaging quantity:
T5(5,000pcs), T10(10,000pcs)

Resistance tolerance

Nominal resistance value
(E-24: 3 digit, E-96: 4 digit, RG3216: all 4 digit)

◆ Electrical Specification

Type	Power ratings			Temperature coefficient of resistance (ppm/ $^\circ\text{C}$)	Resistance range (Ω) Resistance tolerance (%)			Maximum voltage	Resistance value series	Operating temperature	Packaging quantity
	Low	Regular	High		$\pm 0.05\%$ (W)	$\pm 0.1\%$ (B)	$\pm 0.5\%$ (D)				
RG1005	1/32W	1/16W	1/8W	± 5 (V)	100 \leq R<3k			75V			T5
				± 10 (N)	47 \leq R \leq 100k						
				± 25 (P)	47 \leq R \leq 150k						
				± 100 (R)	—	—	10 \leq R<47				
RG1608	1/16W	1/10W	1/6W	± 5 (V)	100 \leq R<5.1k			100V			T10
				± 10 (N)	47 \leq R \leq 274k						
				± 25 (P)	47 \leq R \leq 274k	47 \leq R \leq 1M					
				± 50 (Q)	—	—	10 \leq R<47				
RG2012	1/10W	1/8W	1/4W	± 5 (V)	100 \leq R<10.2k			150V			T5
				± 10 (N)	47 \leq R \leq 475k						
				± 25 (P)	47 \leq R \leq 475k	47 \leq R \leq 2.7M					
				± 50 (Q)	—	—	10 \leq R<47				
RG3216	1/8W	1/4W	—	± 5 (V)	100 \leq R \leq 33.2k			200V			
				± 10 (N)	47 \leq R \leq 1M						
				± 25 (P)	47 \leq R \leq 5.1M						
				± 50 (Q)	—	—	10 \leq R<47				

◆ Dimensions

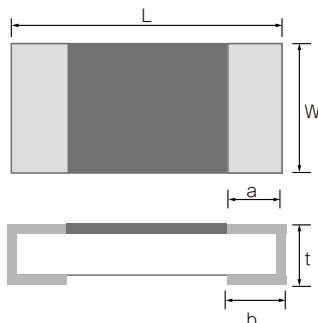

Type	Size (inch)	L	W	a	b	t
RG1005	0402	1.00 \pm 0.1/-0.05	0.50 \pm 0.05	0.20 \pm 0.10	0.25 \pm 0.05	0.35 \pm 0.05
RG1608	0603	1.60 \pm 0.20	0.80 \pm 0.20	0.30 \pm 0.20	0.30 \pm 0.20	0.40 \pm 0.10
RG2012	0805	2.00 \pm 0.20	1.25 \pm 0.20	0.40 \pm 0.20	0.40 \pm 0.20	0.40 \pm 0.10
RG3216	1206	3.20 \pm 0.20	1.60 \pm 0.20	0.50 \pm 0.25	0.50 \pm 0.20	0.40 \pm 0.10

(unit : mm)

◆ Reliability specification

Test Items	Condition (test methods)	Low		Regular		High		Typical
		≤47Ω	≥47Ω	≤47Ω	≥47Ω	≤47Ω	≥47Ω	Low
Short time overload	2.5 x rated voltage, ^{*1} 5 seconds	±0.10%	±0.05%	±0.10%	±0.05%	—	±0.10%	±(0.01%)
Life (biased)	70°C, rated voltage, ^{*1} 90min on 30min off, 1000hours	±0.25%	±0.10%	±0.50%	±0.25%	—	±0.50%	±(0.01%)
High temperature high humidity	85°C, 85%RH, 1/10 of rated power, 90min on 30min off, 1000hours	±0.25%	±0.10%	±0.50%	±0.25%	—	±0.50%	±(0.05%)
Temperature shock	-55°C (30min) ~ 125°C (30min) 1000cycles	±0.25%	±0.10%	±0.25%	±0.10%	—	±0.10%	±(0.01%)
High temperature exposure	155°C, no bias, 1000hours	±0.25%	±0.10%	±0.25%	±0.10%	—	±0.10%	±(0.01%)
Resistance to soldering heat	260±5°C, 10 seconds (reflow)	±0.1%	±0.1%	±0.1%	±0.1%	—	±0.1%	±(0.01%)

*1 Rated voltage is given by $E = \sqrt{R \times P}$ E= rated voltage (V), R=nominal resistance value(Ω), P=rated power(W)
If rated voltage exceeds maximum voltage /element, maximum voltage/element is the rated voltage.

Thin film surface mount resistors

RG series

◆ 10000 hour reliability test data

○ Biased life test

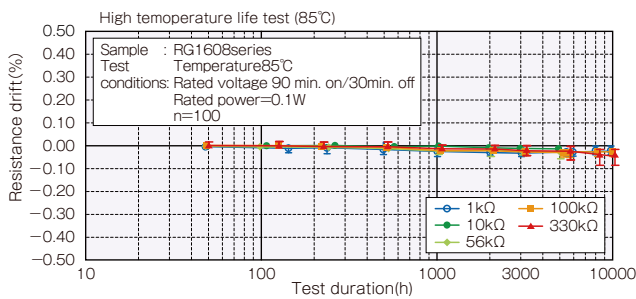

○ High temperature high humidity (biased)

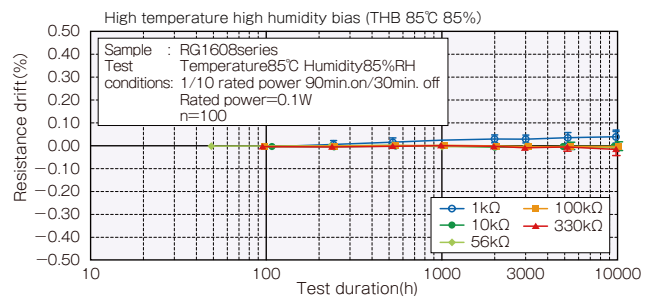

○ Temperature shock

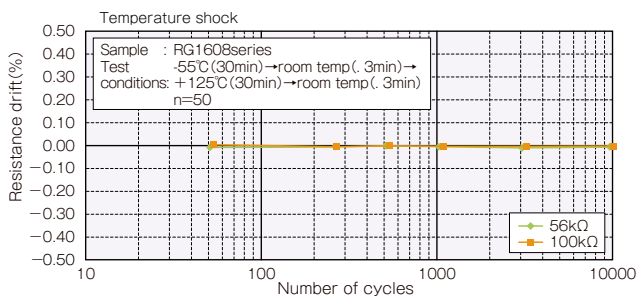

○ High temperature exposure

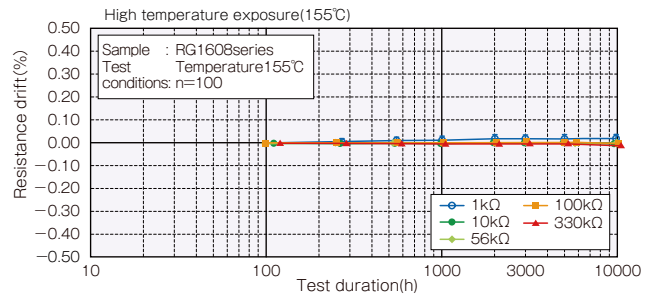

◆ Derating Curve

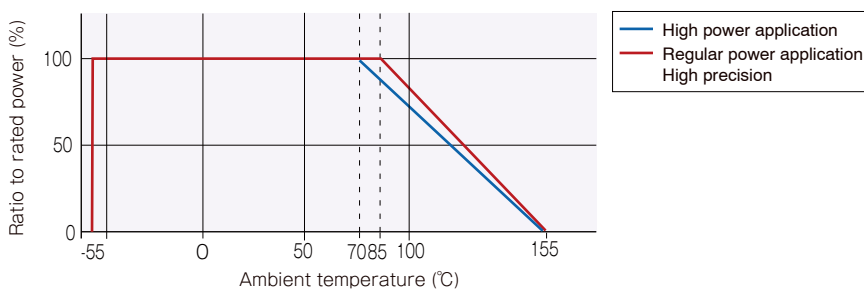

◆ Maximum pulse power limit

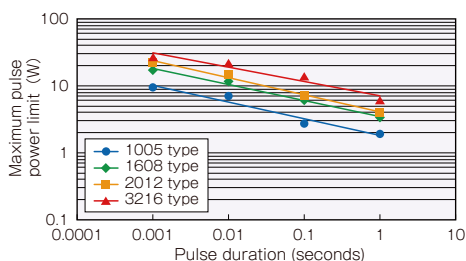

Test procedure

Voltage pulse is applied to the test samples mounted on the test board.

After each pulse, resistance drift is measured. Pulse voltage is increased until the drift exceeds +/-0.5%.

The power at that voltage is defined as the maximum pulse power.

Metal thin film chip resistors (wide temperature range)

■ RGT series

AEC-Q200 Compliant

Features

- Wide temperature operation (Upper category temperature :175°C)
- Long term stability with inorganic passivation
- Resistance tolerance : $\pm 0.1\%$, TCR : $\pm 10\text{ppm}/^\circ\text{C}$
- Thin film structure enabling low noise and anti-sulfur

Applications

- Automotive electronics
- Industrial measurement instrumentation, industrial machines
- Wide temperature operation machines

Thin film surface mount resistors

RGT series



◆ Part numbering system

RGT 2012 N - 105 - B - T5

Series code

Size: RGT1005, RGT1608, RGT2012, RGT3216

Temperature coefficient of resistance

Packaging quantity :
T5(5,000pcs) T10(10,000pcs)

Resistance tolerance
Nominal resistance value
(E-24 : 3 digit, E-96 : 4 digit)

◆ Electrical Specification

Type	Power ratings	Temperature coefficient of resistance (ppm/°C)	Resistance range(Ω) Resistance tolerance		Maximum voltage	Resistance value series	Operating temperature	Packaging quantity
			$\pm 0.1\%$ (B)	$\pm 0.5\%$ (D)				
RGT1005	1/32W	± 10 (N)	47 \leq R \leq 100k		50V	E-24, E-96	-55°C~ 175°C	T5 T10*1
		± 25 (P)	47 \leq R \leq 150k					
RGT1608	1/16W	± 10 (N)	47 \leq R \leq 270k		100V			
		± 25 (P)	47 \leq R \leq 1M					
RGT2012	1/10W	± 10 (N)	47 \leq R \leq 475k		150V			
		± 25 (P)	47 \leq R \leq 2.7M					
RGT3216	1/8W	± 10 (N)	47 \leq R \leq 1M		200V			
		± 25 (P)	47 \leq R \leq 5.1M					

*1 : Resistance tolerance $\pm 0.5\%$ (D) of RGT1005 is available only at T10

◆ Dimensions

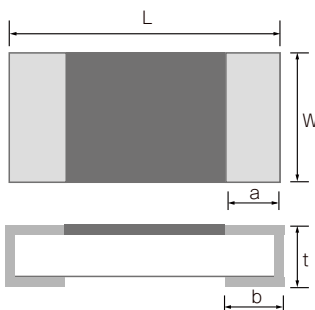

Type	Size (inch)	L	W	a	b	t
RGT1005	0402	1.00 \pm 0.1/-0.05	0.50 \pm 0.05	0.20 \pm 0.10	0.25 \pm 0.05	0.35 \pm 0.05
RGT1608	0603	1.60 \pm 0.20	0.80 \pm 0.25/-0.20	0.30 \pm 0.20	0.30 \pm 0.20	0.40 \pm 0.15/-0.10
RGT2012	0805	2.00 \pm 0.20	1.25 \pm 0.25/-0.20	0.40 \pm 0.20	0.40 \pm 0.20	0.40 \pm 0.15/-0.10
RGT3216	1206	3.20 \pm 0.20	1.60 \pm 0.25	0.50 \pm 0.25	0.50 \pm 0.20	0.40 \pm 0.15/0.10

(unit : mm)

◆ Reliability specification

Test items	Condition(IEC60115-1/JIS C5201-1)	Standard
Short time overload	2.5 x rated voltage ^{*1} , 5 seconds	±0.05%+0.01Ω
Life (biased)	125°C, rated voltage ^{*1} , 90min. ON/ 30min. OFF, 1000hours	±0.25%+0.05Ω
High temperature high humidity	85°C, 85%RH, 1/10 of rated power, 90min. ON/ 30min. OFF, 1000hours	±0.25%+0.05Ω
Temperature shock	-55°C (30min) ~ 125°C(30min) 1000 cycles	±0.1%+0.01Ω
High temperature exposure	175°C, no bias, not mounted, 1000h	±0.1%+0.01Ω
Resistance to soldering heat	260±5°C, 10seconds (reflow)	±0.05%+0.01Ω

*1 Rated voltage is given by $E = \sqrt{R \times P}$ E= rated voltage (V), R=nominal resistance value(Ω), P=rated power(W)
 If rated voltage exceeds maximum voltage /element, maximum voltage/element is the rated voltage.

Thin film surface mount resistors

RGT series

◆ Reliability test data

○ Biased life test

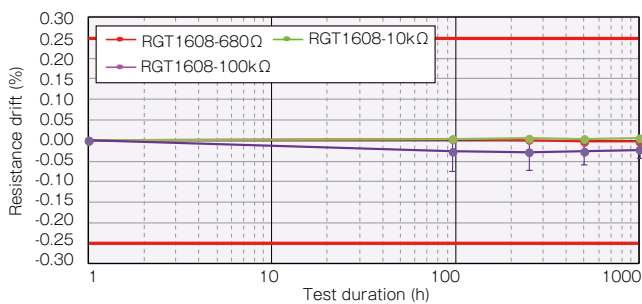

○ High temperature exposure

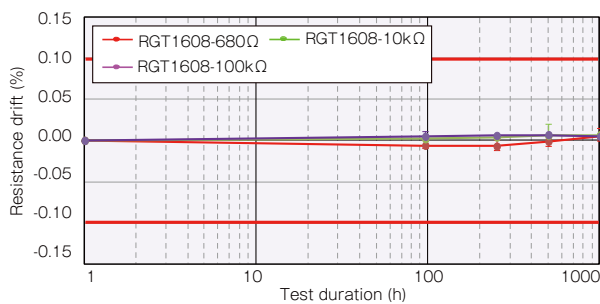

◆ Derating Curve

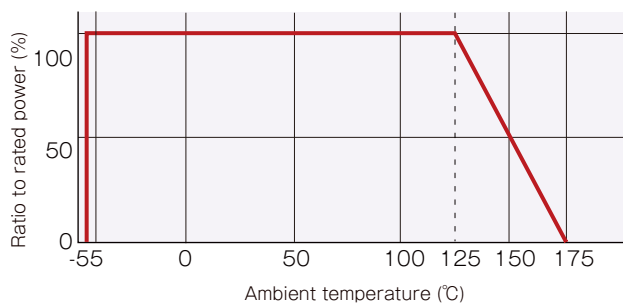

Metal thin film chip resistors (high voltage operation)

■ RGV series

AEC-Q200 Compliant

Features

- High voltage operation is possible because the limiting element voltage is high.
(RGV3225 1000V)
- Long term stability with inorganic Passivation.
- Resistance tolerance : $\pm 0.1\%$, TCR : ± 25 ppm/ $^{\circ}\text{C}$
- Thin film structure enabling low noise and anti-sulfur

Applications

- Automotive electronics
- Industrial measurement instrumentation, Industrial machines.
- High voltage circuit and equipment.

Thin film surface mount resistors

RGT series



◆ Part numbering system

RGV 3216 P - 2004 - B - T5

Series code

Size : RGV3216, RGV3225

Temperature coefficient of resistance

Nominal resistance value(all 4 digit)

T1(1,000pcs) T5(5,000pcs)

Resistance tolerance

◆ Electrical Specification

Type	Power ratings	Temperature coefficient of resistance	Resistance range(Ω) Resistance tolerance		Maximum voltage	Resistance value series	Operating temperature	Packaging quantity
		(ppm/ $^{\circ}\text{C}$)	$\pm 0.1\%$ (B)	$\pm 0.5\%$ (D)				
RGV3216	1/4W	± 25 (P)	$120\text{K}\Omega \leq R \leq 3\text{M}\Omega$		700V	E-24, E-96	$-55^{\circ}\text{C} \sim 155^{\circ}\text{C}$	T1 T5
		± 50 (Q)						
RGV3225	1/3W	± 25 (P)	$120\text{K}\Omega \leq R \leq 4.3\text{M}\Omega$		1000V	E-24, E-96	$-55^{\circ}\text{C} \sim 155^{\circ}\text{C}$	T1 T5
		± 50 (Q)						

◆ Dimensions

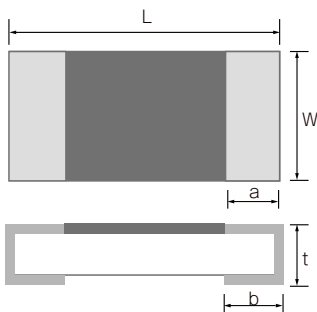

Type	Size (inch)	L	W	a	b	t
RGV3216	1206	3.20 ± 0.20	1.60 ± 0.25	0.50 ± 0.25	0.50 ± 0.20	$0.40 + 0.15 / - 0.1$
RGV3225	1210	3.20 ± 0.20	2.50 ± 0.25	0.50 ± 0.25	0.50 ± 0.20	$0.40 + 0.15 / - 0.1$

(unit : mm)

◆ Reliability specification

Test items	Condition(IEC60115-1/JIS C5201-1)	Standard
Life (biased)	85°C, rated voltage ^{*1} , 90min. ON/ 30min. OFF, 1000hours	±0.05%+0.05Ω
High temperature high humidity	85°C, 85%RH, 1/10 of rated power, 90min. ON/ 30min. OFF, 1000hours	±0.1%+0.05Ω
Temperature shock	-55°C (30min) ~ 125°C(30min) 1000 cycles	±0.1%+0.01Ω
High temperature exposure	155°C, no bias, not mounted, 1000h	±0.1%+0.01Ω
Resistance to soldering heat	260±5°C, 10seconds (reflow)	±0.05%+0.01Ω

*1 Rated voltage is given by $E = \sqrt{R \times P}$ E= rated voltage (V), R=nominal resistance value(Ω), P=rated power(W)
If rated voltage exceeds maximum voltage /element, maximum voltage/element is the rated voltage.

◆ Derating Curve

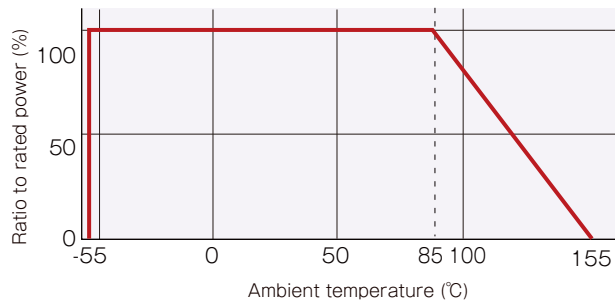

Non-magnetic metal thin film chip resistors

NRG series

Features

- Thin film chip resistors using non-magnetic materials
- Long term stability with inorganic passivation
- High precision resistance tolerance: $\pm 0.05\%$, very small TCR: $\pm 5\text{ppm}/^\circ\text{C}$
- Thin film structure enabling low noise and anti-sulfur

Applications

- Medical electronics, industrial measurement instrumentation
- equipment/devices under magnetic field



Thin film surface mount resistors



NRG series

◆ Part numbering system

NRG 2012 N - 104 - W - T1

Series code

Size: NRG1005, NRG1608, NRG2012, NRG3216

Temperature coefficient of resistance

Packaging quantity:
T5(5,000pcs) T10(10,000pcs)

Resistance tolerance

Nominal resistance value
(E-24: 3 digit, E-96: 4 digit, NRG3216: all 4 digit)

◆ Electrical Specification

Type	Power ratings	Temperature coefficient of resistance (ppm/ $^\circ\text{C}$)	Resistance range(Ω) Resistance tolerance			Maximum voltage	Resistance value series	Operating temperature	Packaging quantity
			$\pm 0.05\%$ (W)	$\pm 0.1\%$ (B)	$\pm 0.5\%$ (D)				
NRG1005	1/16W	± 5 (V)	$100 \leq R \leq 3k$		—	75V	E-24, E-96	$-55^\circ\text{C} \sim 155^\circ\text{C}$	T5 T10*1
		± 10 (N)	$47 \leq R \leq 100k$						
		± 25 (P)	$47 \leq R \leq 150k$						
		± 100 (R)	—	$10 \leq R \leq 47$					
NRG1608	1/10W	± 5 (V)	$100 \leq R < 5.1k$		100V	E-24, E-96	$-55^\circ\text{C} \sim 155^\circ\text{C}$	T5	
		± 10 (N)	$47 \leq R \leq 270k$						
		± 25 (P)	$47 \leq R \leq 270k$	$47 \leq R \leq 332k$					$47 \leq R \leq 360k$
		± 50 (Q)	—	—					$10 \leq R < 47$
NRG2012	1/8W	± 5 (V)	$100 \leq R < 10.2k$		150V	E-24, E-96	$-55^\circ\text{C} \sim 155^\circ\text{C}$	T5	
		± 10 (N)	$47 \leq R \leq 475k$						
		± 25 (P)	$47 \leq R \leq 475k$	$47 \leq R \leq 1M$					
		± 50 (Q)	—	—					$10 \leq R < 47$
NRG3216	1/4W	± 5 (V)	$100 \leq R < 33.2k$		200V	E-24, E-96	$-55^\circ\text{C} \sim 155^\circ\text{C}$	T5	
		± 10 (N)	$47 \leq R \leq 1M$						
		± 25 (P)	$47 \leq R \leq 1M$						
		± 50 (Q)	—	—					$10 \leq R < 47$

*1 : Resistance tolerance $\pm 0.5\%$ (D) of NRG1005 is available only at T10

◆ Dimensions

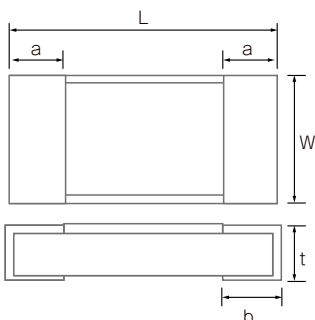

Type	Size (inch)	L	W	a	b	t
NRG1005	0402	1.00 ± 0.05	0.50 ± 0.05	0.20 ± 0.10	0.25 ± 0.05	0.35 ± 0.05
NRG1608	0603	1.60 ± 0.20	$0.80 + 0.25 / - 0.20$	0.30 ± 0.20	0.30 ± 0.20	$0.40 + 0.15 / - 0.10$
NRG2012	0805	2.00 ± 0.20	$1.25 + 0.25 / - 0.20$	0.40 ± 0.20	0.40 ± 0.20	$0.40 + 0.15 / - 0.10$
NRG3216	1206	3.20 ± 0.20	1.60 ± 0.25	0.50 ± 0.25	0.50 ± 0.20	$0.40 + 0.15 / - 0.10$

(unit : mm)

◆ Reliability specification

Test items	Condition (test methods (MIL-PRF-55342/JIS C5201-1))	Standard
Short time overload	2.5 x rated voltage, ^{*1} 5seconds	±0.5%+0.01Ω
Life (biased)	70°C, rated voltage, ^{*1} 90min on 30min off, 1000hours	±0.5%+0.05Ω
High temperature high humidity	85°C, 85%RH, 1/10 of rated power, 90min on 30min off, 1000hours	±0.5%+0.01Ω
Temperature shock	-55°C (30min) ~ 125°C (30min) 1000 cycles	±0.5%+0.01Ω
High temperature exposure	155°C, no bias, 1000hours	±0.5%+0.01Ω
Resistance to soldering heat	260±5°C, 10 seconds (reflow)	±0.05%+0.01Ω

*1 Rated voltage is given by $E = \sqrt{R \times P}$ E= rated voltage (V), R=nominal resistance value(Ω), P=rated power(W)
 If rated voltage exceeds maximum voltage /element, maximum voltage/element is the rated voltage.

◆ Reliability test data

○ Biased life test

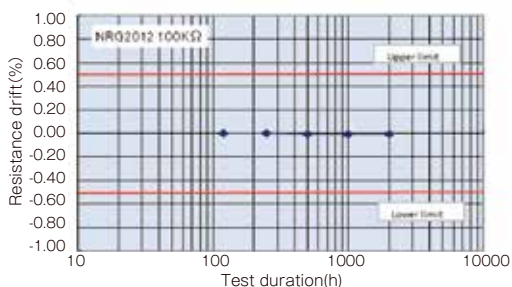

○ High temperature high humidity (biased)

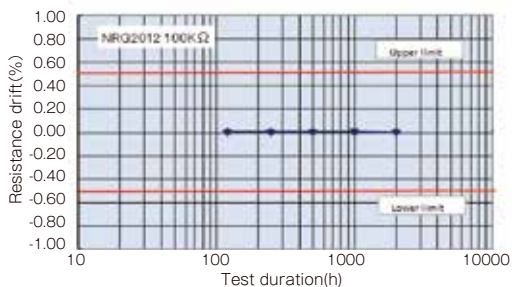

○ Temperature shock

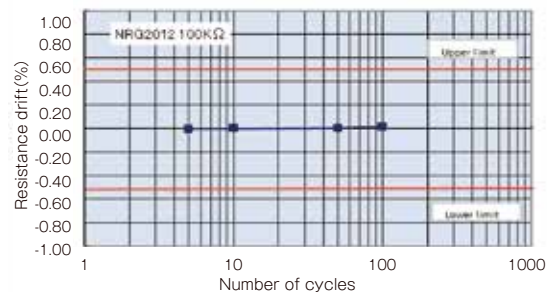

◆ Derating Curve

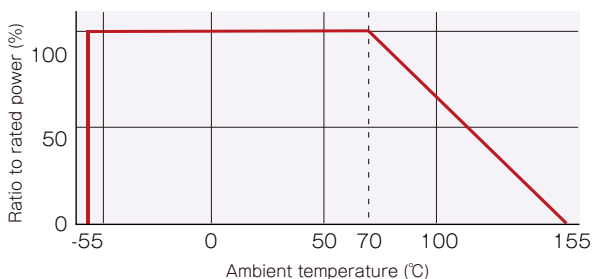

Audio thin film chip resistors (high precision)

■ RS series

AEC-Q200 Compliant

Features

- Improved low noise thin film character even further
- Choice among the same resistance/size according to the user's sound preference
- Precision resistance tolerance: $\pm 0.1\%$, very small TCR: $\pm 25\text{ppm}/^\circ\text{C}$

Applications

- High quality audio equipment
- Automotive audio equipment
- Mobile audio equipment , smartphones

Thin film surface mount resistors



RS series

◆ Part numbering system

RS 1005P - 102 - B - T10 - 3

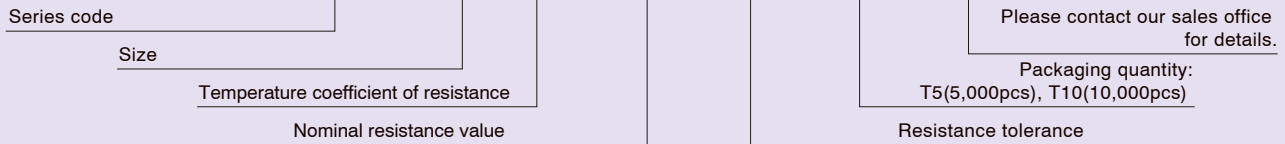

◆ Electrical Specification

Type	Power ratings		Temperature coefficient of resistance (ppm/°C)	Resistance range(Ω) Resistance tolerance		Maximum voltage	Resistance value series	Operating temperature	Packaging quantity
	Low	Regular		$\pm 0.1\%(B)$	$\pm 0.5\%(D)$				
RS1005	1/32W	1/16W	$\pm 25(P)$	47 $\leq R \leq$ 100K		75V	E-6	-55°C ~ 155°C	T5 T10
RS2012	1/10W	1/8W	$\pm 25(P)$	47 $\leq R \leq$ 100K		150V			T5

* Please contact our sales office for details.

◆ Dimensions

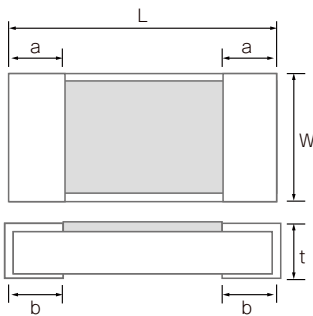

Type	Size (inch)	L	W	a	b	t
RS1005	0402	1.00 \pm 0.10/-0.05	0.50 \pm 0.10	0.20 \pm 0.10	0.25 \pm 0.05	0.35 \pm 0.05
RS2012	0805	2.00 \pm 0.20	1.25 \pm 0.25/-0.20	0.40 \pm 0.20	0.40 \pm 0.20	0.40 \pm 0.15/-0.10

(unit : mm)

◆ Derating Curve

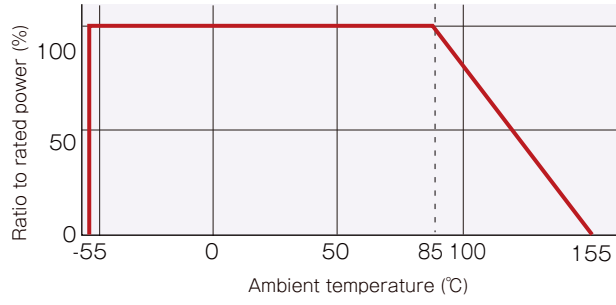

High power thin film chip resistors (long side terminal)

■ PRG series

AEC-Q200 Compliant

Features

- Long side terminal enabling higher power capability
- Significantly larger power handling capability than conventional same size resistors
Size: 2010 ~ 6432, power ratings: 0.5 ~ 3.0W, Resistance range: 2.5 ~ 250K Ω
- Precision resistance tolerance: $\pm 0.1\%$, very small TCR: $\pm 25\text{ppm}/^\circ\text{C}$
- Thin film structure enabling low noise and anti-sulfur

Applications

- Automotive electronics
- DC motor, inverters
- Robotics, Industrial control system



Thin film surface mount resistors

PRG series

◆ Part numbering system

PRG 3216 P - 1001 - B - T5

Series code

Size: PRG2010, PRG3216
PRG5025, PRG6432

Temperature coefficient of resistance

Nominal resistance value (E-24, E-96: all 4 digit)

Packaging quantity: T4(4,000pcs)
(PRG6432, PRG5025)
T5(5,000pcs)
(PRG3216, PRG2010)

Resistance tolerance

◆ Electrical Specification

Type	Power ratings	Temperature coefficient of resistance (ppm/ $^\circ\text{C}$)	Resistance range(Ω) Resistance tolerance		Maximum voltage	Resistance value series	Operating temperature	Packaging quantity
			$\pm 0.1\%$ (B)	$\pm 0.5\%$ (D)				
PRG2010	0.5W	± 25 (P)	$47 \leq R \leq 25k$	$10 \leq R \leq 25k$	100V	E-24, E-96	$-55^\circ\text{C} \sim 155^\circ\text{C}$	T5
		± 50 (Q)		$2.5 \leq R \leq 25k$				
PRG3216	1.0W	± 25 (P)	$47 \leq R \leq 100k$	$10 \leq R \leq 100k$	150V			
		± 50 (Q)		$2.5 \leq R \leq 100k$				
PRG5025	1.5W ~ 2.0W	± 25 (P)	$47 \leq R \leq 200k$	$10 \leq R \leq 200k$	200V			
		± 50 (Q)		$2.5 \leq R \leq 200k$				
PRG6432	2.0W ~ 3.0W	± 25 (P)	$47 \leq R \leq 250k$	$10 \leq R \leq 250k$	400V			T4
		± 50 (Q)		$2.5 \leq R \leq 250k$				

◆ Dimensions

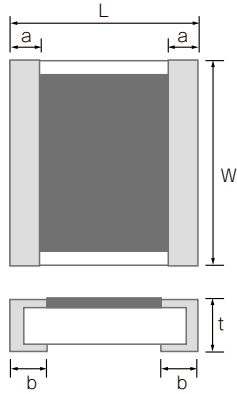

Type	Size (inch)	W	L	a	b	t
PRG2010	0804	2.00±0.20	1.00±0.20	0.20±0.10	0.25±0.10	0.35±0.10
PRG3216	1206	3.20+0.40/-0.20	1.60±0.20	0.30±0.20	0.35±0.20	0.45+0.15/-0.10
PRG5025	2010	5.00±0.20	2.50±0.20	0.55±0.20	0.60±0.20	0.45+0.15/-0.10
PRG6432	2512	6.40+0.20/-0.40	3.20±0.20	0.40±0.20	0.55±0.20	0.45+0.15/-0.10

(unit : mm)

Thin film surface mount resistors

◆ Reliability specification

Test items	Condition (test methods (JIS C5201-1))	Standard	
		≤47Ω	≥47Ω
Life (biased)	70°C, rated voltage, ^{*1} 90min on 30min off, 1000hours	±(0.25%+0.05Ω)	±(0.1%+0.01Ω)
High temperature high humidity	85°C, 85%RH, 1/10 of rated power, 90min on 30min off, 1000hours	±(0.25%+0.05Ω)	±(0.1%+0.01Ω)
Temperature shock	-55°C (30min) ~ 125°C (30min) 1000cycles	±(0.25%+0.05Ω)	±(0.1%+0.01Ω)
High temperature exposure	155°C, no bias, 1000hours	±(0.25%+0.05Ω)	±(0.1%+0.01Ω)
Resistance to soldering heat	260±5°C, 10 seconds (reflow)	±(0.1%+0.01Ω)	±(0.05%+0.01Ω)

*1 Rated voltage is given by $E = \sqrt{R \times P}$

E= rated voltage (V), R=nominal resistance value(Ω), P=rated power(W)

If rated voltage exceeds maximum voltage /element, maximum voltage/element is the rated voltage.

PRG series

High power thin film chip resistors (long side terminal)

PRG series

◆ Reliability test data

○ Biased life test

Thin film surface mount resistors

PRG series

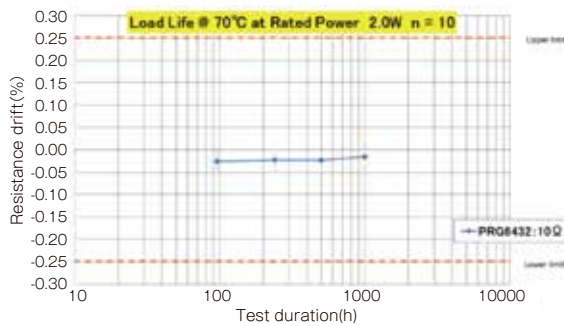
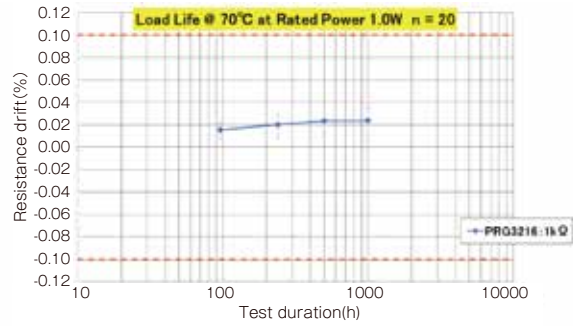
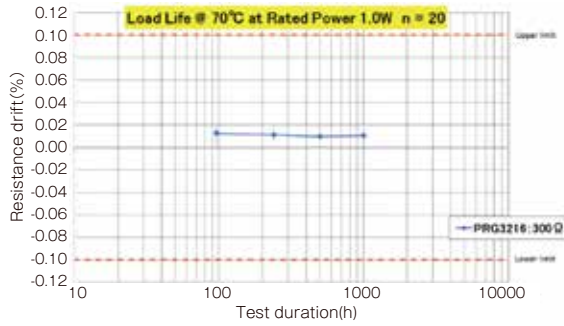

○ High temperature high humidity (biased)

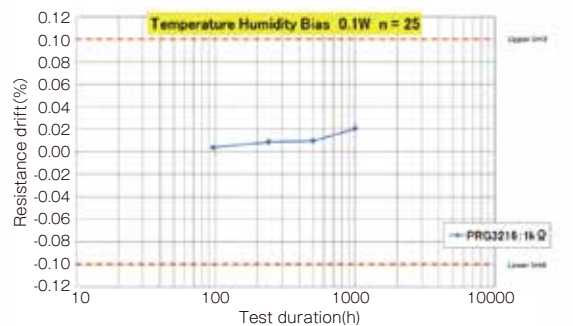
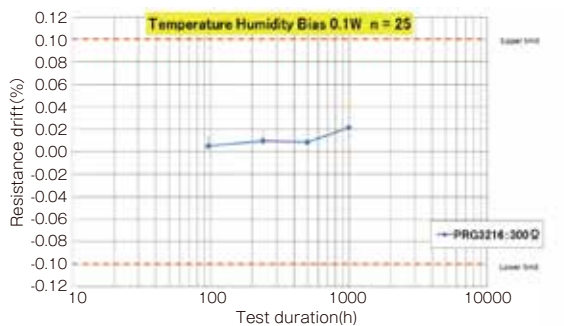
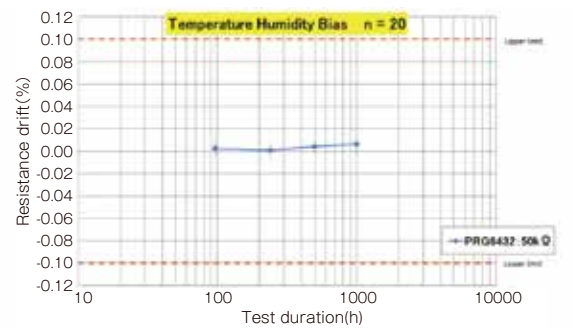
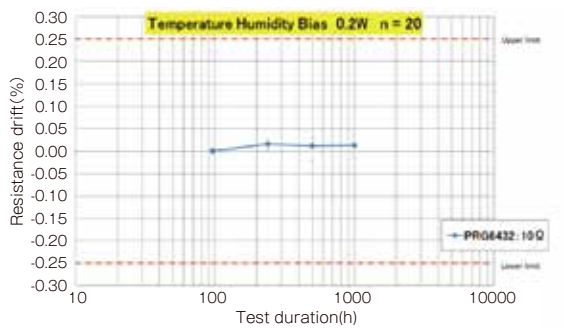

○ Temperature shock

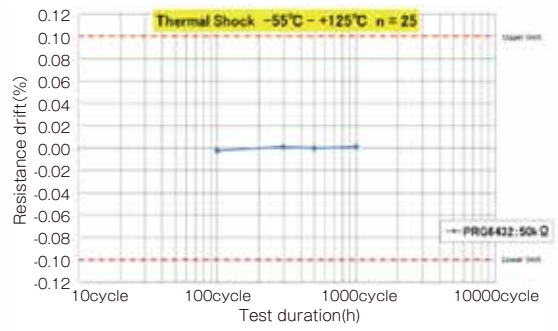
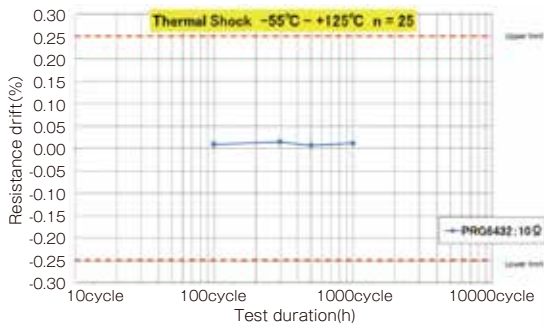
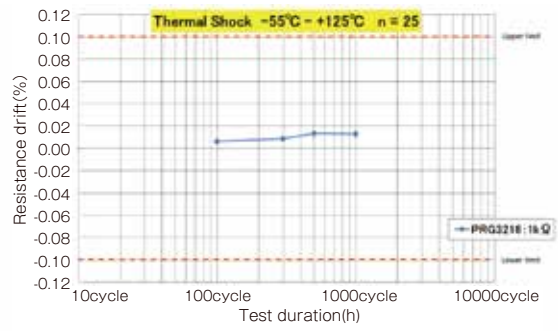
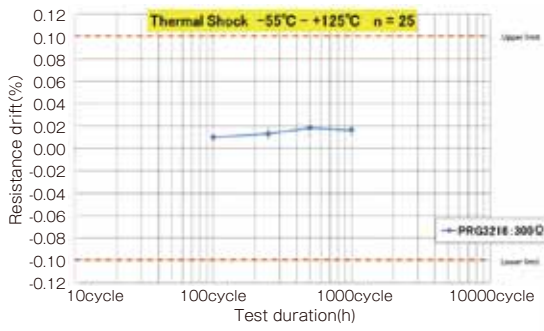

○ High temperature exposure

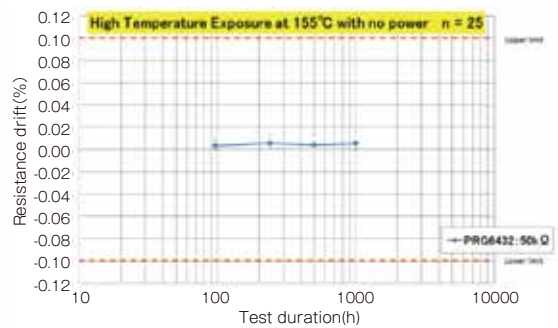
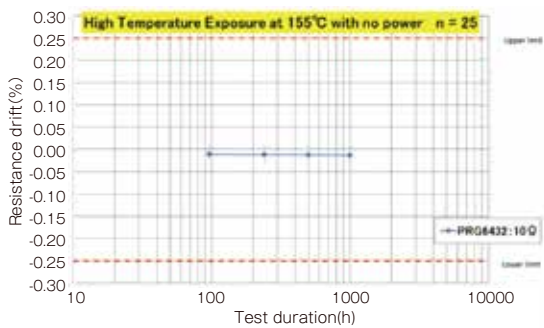
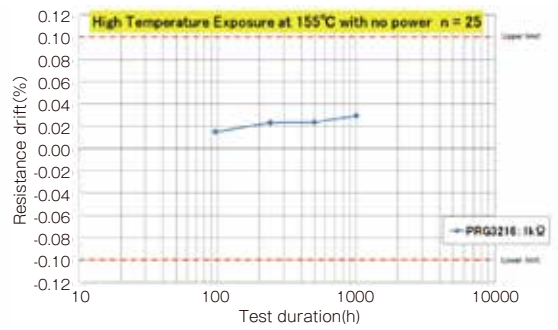
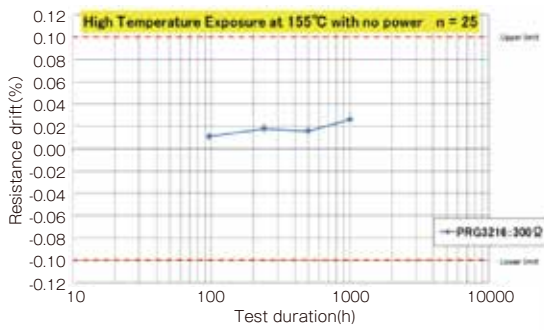

◆ Derating Curve

○ PRG3216

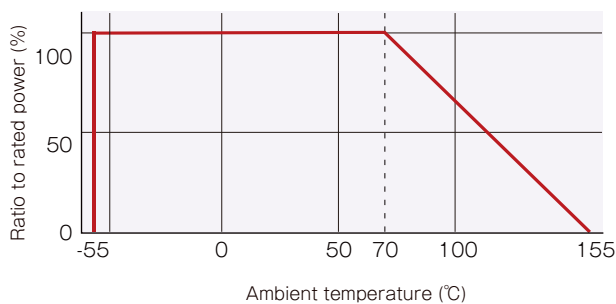

○ PRG6432

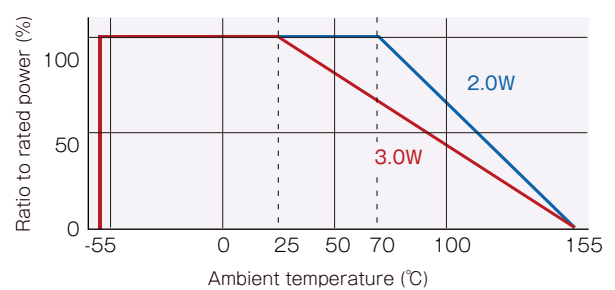

High power thin film chip resistors (short side terminal)

■ HRG series

AEC-Q200 Compliant

Features

- Wider bottom terminal enabling higher power capability (short side terminal)
- Significantly larger power handling capability than existing same size resistors
Size: 3216, Power rating: 1.0W, Resistance range: 10 ~ 100K Ω
- Precision resistance tolerance: $\pm 0.1\%$, very small TCR: $\pm 25\text{ppm}/^\circ\text{C}$
- Thin film structure enabling low noise and anti-sulfur

Applications

- Power source related devices
- DC motors, inverters
- Robotics, Industrial control system



Thin film surface mount resistors

HRG series

◆ Part numbering system

HRG 3216 P - 1001 - B - T5

Series code

Size: HRG3216

Temperature coefficient of resistance

Nominal resistance value (E-24, E-96: all 4 digit)

Resistance tolerance

Packaging quantity:
T1(1,000pcs), T5(5,000pcs)

◆ Electrical Specification

Type	Power ratings	Temperature coefficient of resistance (ppm/ $^\circ\text{C}$)	Resistance range(Ω) Resistance tolerance		Maximum voltage	Resistance value series	Operating temperature	Packaging quantity
			$\pm 0.1\%$ (B)	$\pm 0.5\%$ (D)				
HRG3216	1.0W	± 25 (P)	$47 \leq R \leq 100\text{k}$		200V	E-24, E-96	$-55^\circ\text{C} \sim 155^\circ\text{C}$	T1 T5
		± 50 (Q)	$47 \leq R \leq 100\text{k}$	$10 \leq R \leq 100\text{k}$				

◆ Dimensions

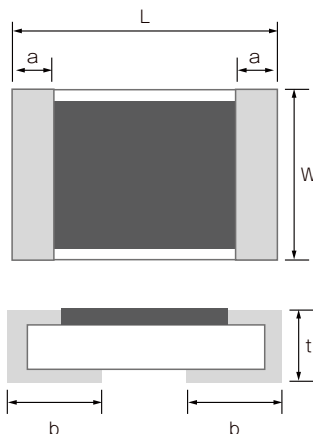

Type	Size (inch)	L	W	a	b	t
HRG3216	1206	3.20 ± 0.20	1.60 ± 0.20	0.50 ± 0.25	1.10 ± 0.20	0.45 ± 0.10

(unit : mm)

◆ Reliability specification

Test items	Condition (test methods (JIS C5201-1))	Standard	
		≤47Ω	≥47Ω
Life (biased)	70°C, rated voltage, ^{*1} 90min on 30min off, 1000hours	±(0.5%+0.05Ω)	±(0.25%+0.01Ω)
High temperature high humidity	85°C, 85%RH, 1/10 of rated power, 90min on 30min off, 1000hours	±(0.25%+0.05Ω)	±(0.1%+0.01Ω)
Temperature shock	-55°C (30min) ~ 125°C (30min) 1000cycles	±(0.25%+0.05Ω)	±(0.1%+0.01Ω)
High temperature exposure	155°C, no bias, 1000hours	±(0.25%+0.05Ω)	±(0.1%+0.01Ω)
Resistance to soldering heat	260±5°C, 10 seconds (reflow)	±(0.25%+0.05Ω)	±(0.1%+0.01Ω)

*1 Rated voltage is given by $E = \sqrt{R \times P}$
 E= rated voltage (V), R=nominal resistance value(Ω), P=rated power(W)
 If rated voltage exceeds maximum voltage /element, maximum voltage/element is the rated voltage.

Thin film surface mount resistors

◆ Reliability test data

○ Biased life test

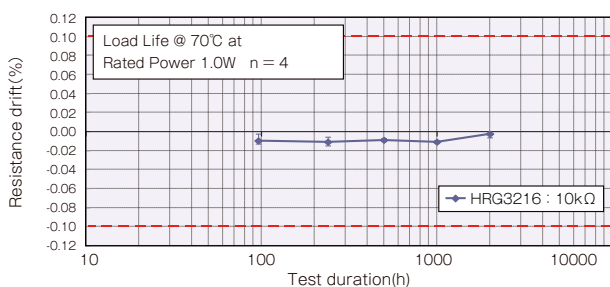

○ High temperature high humidity (biased)

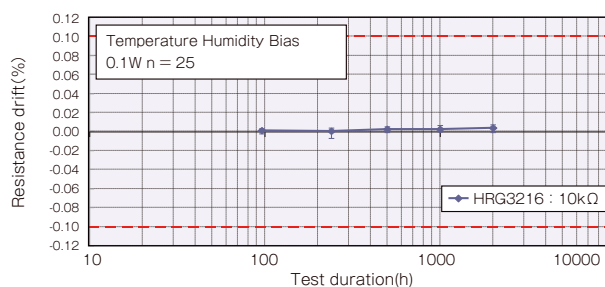

○ Temperature shock

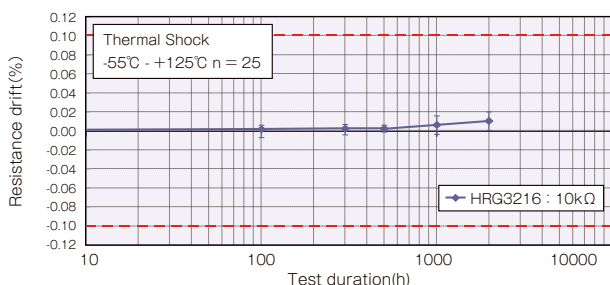

○ High temperature exposure

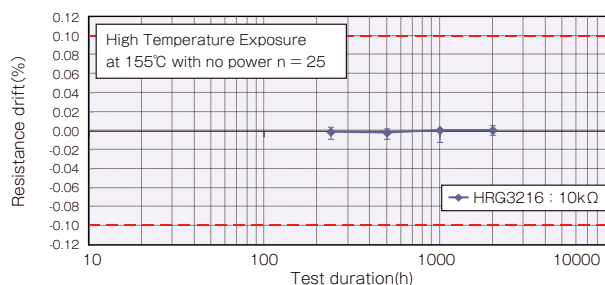

HRG series

◆ Derating Curve

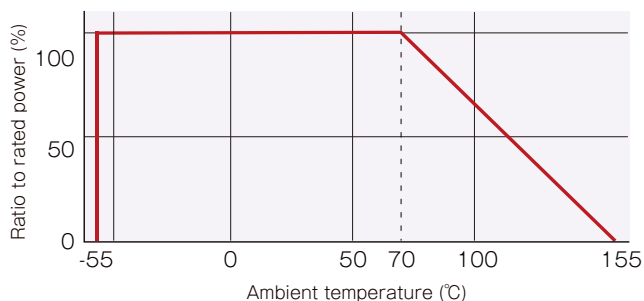

Anti-surge thin film chip resistors

■ MRG series

AEC-Q200 Compliant

Features

- Significant improvement of anti-surge capability comparing to existing thin film resistors
- Precision resistance tolerance: $\pm 0.1\%$, very small TCR: $\pm 10\text{ppm}/^\circ\text{C}$
- Thin film structure enabling low noise and anti-sulfur

Applications

- Power source related devices
- Automotive electronics
- Robotics, Industrial control system



Thin film surface mount resistors



MRG series

◆ Part numbering system

MRG 2012 N - 104 - D - T5

Series code

Size: MRG2012, MRG3216, MRG5025

Temperature coefficient of resistance

Packaging quantity: T5(5,000pcs)
(MRG2012, MRG3216)
T4(4,000pcs) (MRG5025)

Resistance tolerance

Nominal resistance value
(E-24, E-96, MRG3216, MRG5025: all 4 digit)

◆ Electrical Specification

Type	Power ratings	Temperature coefficient of resistance	Resistance range(Ω) Resistance tolerance	Maximum voltage	Resistance value series	Operating temperature	Packaging quantity
		(ppm/ $^\circ\text{C}$)	$\pm 0.5\%$ (D)				
MRG2012	1/10W	± 10 (N)	$100 \leq R \leq 1\text{M}$	150V	E-24, E-96	$-55^\circ\text{C} \sim 155^\circ\text{C}$	T5
		± 25 (P)					
MRG3216	1/8W	± 10 (N)	$100 \leq R \leq 2\text{M}$	200V	E-24, E-96	$-55^\circ\text{C} \sim 155^\circ\text{C}$	T5
		± 25 (P)					
MRG5025	1/2W	± 10 (N)	$100 \leq R \leq 2\text{M}$	300V	E-24, E-96	$-55^\circ\text{C} \sim 155^\circ\text{C}$	T4
		± 25 (P)					

◆ Dimensions

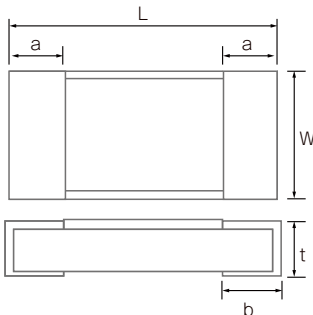

Type	Size (inch)	L	W	a	b	t
MRG2012	0805	2.00 ± 0.20	$1.25 + 0.25 / - 0.20$	0.40 ± 0.20	0.40 ± 0.20	$0.40 + 0.15 / - 0.10$
MRG3216	1206	3.20 ± 0.20	1.60 ± 0.25	0.50 ± 0.25	0.50 ± 0.25	$0.40 + 0.15 / - 0.10$
MRG5025	2010	5.00 ± 0.20	2.50 ± 0.25	0.60 ± 0.25	0.60 ± 0.25	$0.45 + 0.15 / - 0.10$

(unit : mm)

◆ Reliability specification

Test items	Condition (test methods (MIL-PRF-55342/JIS C5201-1))	Standard
Short time overload	2.5 x rated voltage,*1 5seconds	±0.5%+0.01Ω
Life (biased)	85°C, rated voltage,*1 90min on 30min off, 2000hours	±0.25%+0.01Ω
High temperature high humidity	85°C, 85%RH, 1/10 of rated power, 90min on 30min off, 2000hours	±0.25%+0.01Ω
Temperature shock	-55°C (30min) ~ 125°C (30min) 2000cycles	±0.25%+0.01Ω
High temperature exposure	155°C, no bias, 2000hours	±0.5%+0.01Ω
ESD (HBM)	4KV (Positive 3times, negative 3 times)	±0.5%+0.05Ω
Resistance to soldering heat	260±5°C, 10 seconds (reflow)	±0.05%+0.01Ω

*1 Rated voltage is given by $E = \sqrt{R \times P}$ E= rated voltage (V), R=nominal resistance value(Ω), P=rated power(W)
If rated voltage exceeds maximum voltage /element, maximum voltage/element is the rated voltage.

Thin film surface mount resistors

MRG series

◆ Reliability test data

○ Biased life test

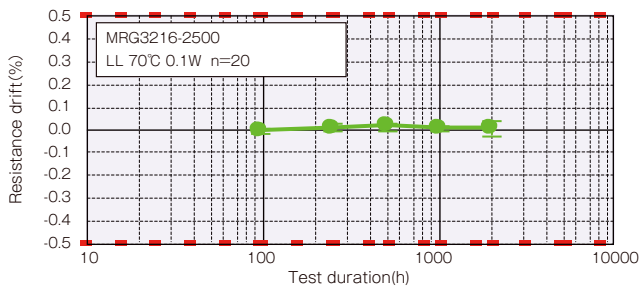

○ High temperature high humidity (biased)

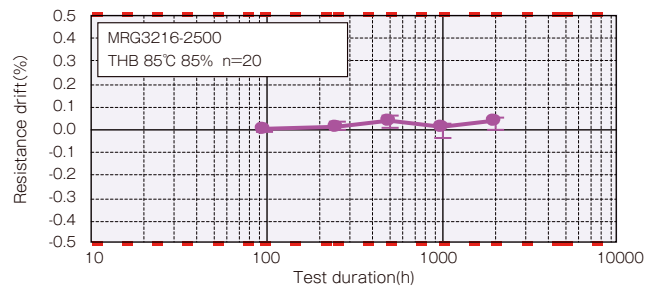

○ Temperature shock

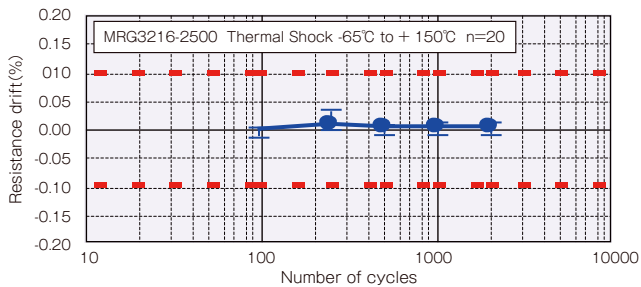

○ High temperature exposure

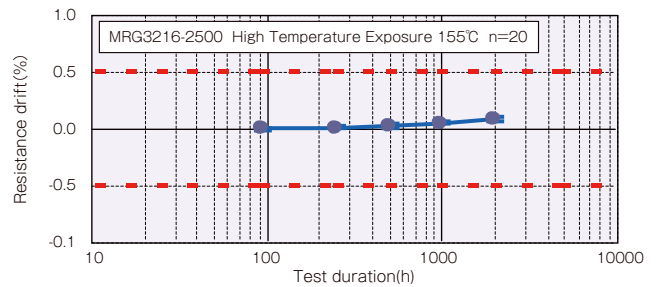

◆ Derating Curve

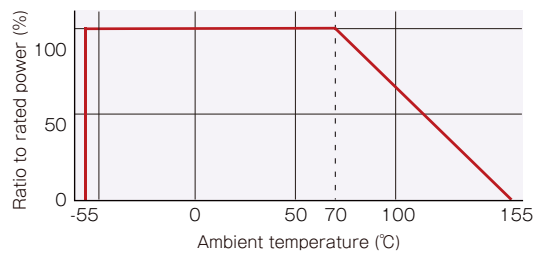

◆ Maximum pulse power limit (single pulse)

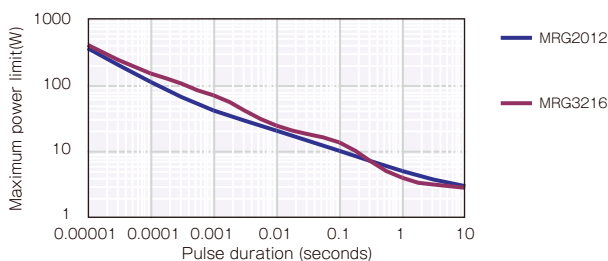

◆ Maximum pulse power limit (multiple pulses)

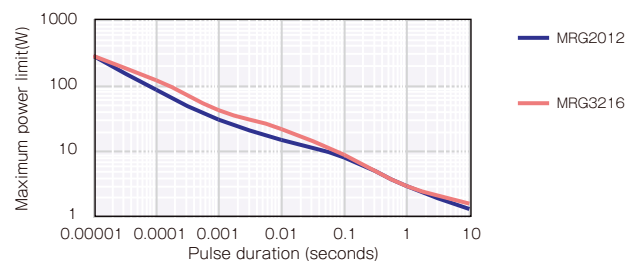

High temperature thin film chip resistors

■ RGA series

AEC-Q200 Compliant



Features

- Conductive epoxy compatible
- Operating temperature up to 230°C
- Resistance tolerance: $\pm 0.1\%$, TCR: $\pm 10\text{ppm}/^\circ\text{C}$
- Thin film structure enabling low noise and anti-sulfur

Applications

- Automotive electronics
- Equipment used in high temperature
- Downhole drilling

Thin film surface mount resistors



RGA series

◆ Part numbering system

RGA 2012 N - 104 - B - T1

Series code

Size: RGA1005, RGA1608, RGA2012

Temperature coefficient of resistance

Nominal resistance value (E-24: 3digit, E-96: 4digit)

Packaging quantity:
T1 (1,000pcs), T5 (5,000pcs)

Resistance tolerance

◆ Electrical Specification

Type	Power ratings	Temperature coefficient of resistance (ppm/°C)	Resistance range(Ω) Resistance tolerance		Maximum voltage	Resistance value series	Operating temperature	Packaging quantity
			$\pm 0.1\%$ (B)	$\pm 0.5\%$ (D)				
RGA1005	1/32W	± 10 (N)	47 \leq R \leq 100k		50V	E-24, E-96	-55°C ~ 230°C	T1 T5
		± 25 (P)	10 \leq R \leq 100k					
RGA1608	1/16W	± 10 (N)	47 \leq R \leq 274k		100V	E-24, E-96	-55°C ~ 230°C	T1 T5
		± 25 (P)	10 \leq R \leq 332k	10 \leq R \leq 360k				
RGA2012	1/10W	± 10 (N)	47 \leq R \leq 475k		150V	E-24, E-96	-55°C ~ 230°C	T1 T5
		± 25 (P)	10 \leq R \leq 1M					

◆ Dimensions

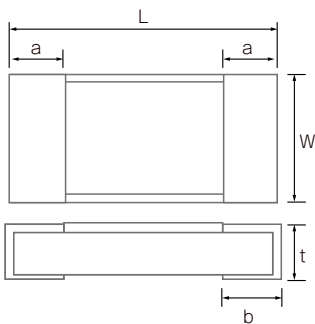

Type	Size (inch)	L	W	a	b	t
RGA1005	0402	1.00 \pm 0.1/-0.05	0.50 \pm 0.10	0.20 \pm 0.10	0.25 \pm 0.05	0.35 \pm 0.05
RGA1608	0603	1.60 \pm 0.20	0.80 \pm 0.25/-0.20	0.30 \pm 0.20	0.30 \pm 0.20	0.40 \pm 0.15/-0.10
RGA2012	0805	2.00 \pm 0.20	1.25 \pm 0.25/-0.20	0.40 \pm 0.20	0.40 \pm 0.20	0.40 \pm 0.15/-0.10

(unit : mm)

◆ Reliability specification

Test items	Condition (test methods (MIL-PRF-55342/JIS C5201-1))	Standard
Short time overload	2.5 x rated voltage,*1 5seconds	±(0.1%+0.01Ω)
Life (biased)	125°C, rated voltage,*1 90min on 30min off, 1000hours	±(0.2%+0.05Ω)
High temperature high humidity	85°C, 85%RH, 1/10 of rated power, 90min on 30min off, 1000hours	±(0.2%+0.01Ω)
Temperature shock	-55°C (30min) ~ 125°C (30min) 1000cycles	±(0.2%+0.01Ω)
High temperature exposure	155°C, no bias, 1000hours	±(0.2%+0.05Ω)
Vibration	Frequency 10Hz ~ 500Hz, vibration amplitude 1.5mm or acceleration 10gn test duration for each of 3 axis: 6 hours	±(0.2%+0.05Ω)
Resistance to soldering heat	260±5°C, 10 seconds (reflow)	±(0.5%+0.01Ω)

*1 Rated voltage is given by $E = \sqrt{R \times P}$
 E= rated voltage (V), R=nominal resistance value(Ω), P=rated power(W)
 If rated voltage exceeds maximum voltage /element, maximum voltage/element is the rated voltage.

Thin film surface mount resistors

RGA series

◆ Reliability test data

○ Biased life test

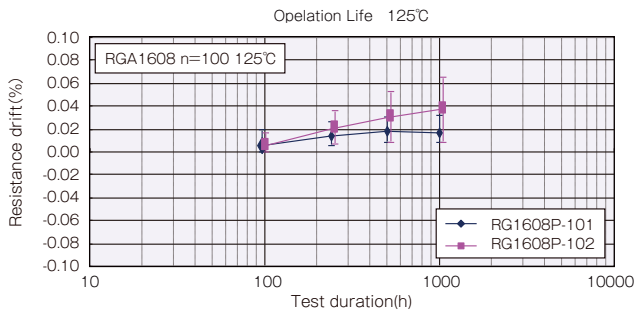

○ High temperature high humidity (biased)

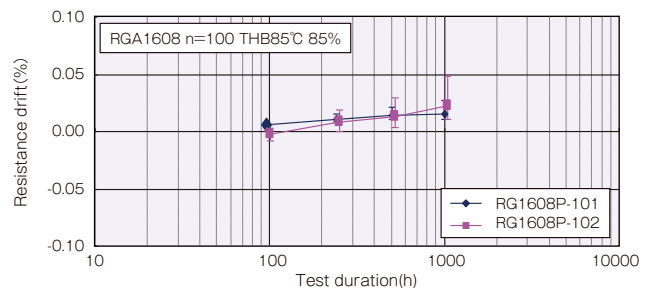

○ Temperature shock

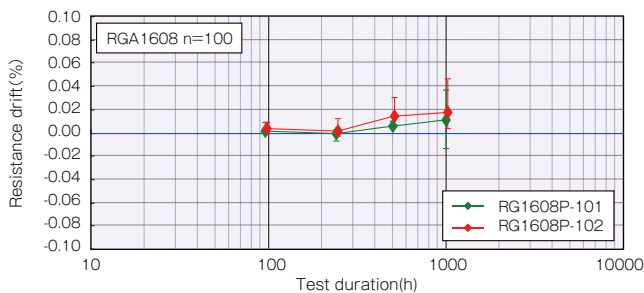

○ High temperature exposure

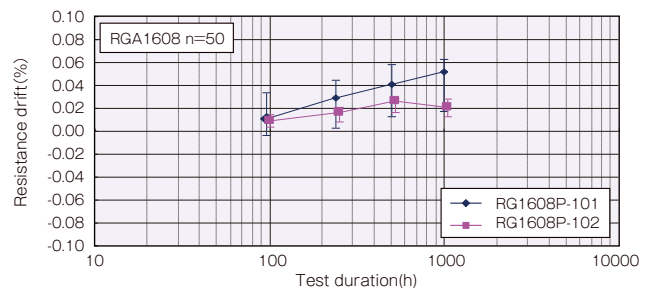

◆ Derating Curve

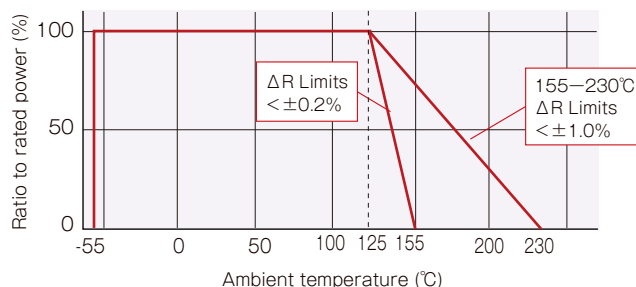

Metal thin film chip resistors (precision)

RR series

Features

- Precision chip resistors excellent in resistance tolerance, TCR, frequency performance, noise characteristics, and linearity.

Applications

- Consumer electronics that requires precision resistors
- All purpose resistors in any area of electronics

Thin film surface mount resistors



◆ Part numbering system

RR 0816 P - 102 - D - (M) - (*)**

Series code

Size: RR0306, RR0510,
RR0816, RR1220,

Temperature coefficient of resistance

Nominal Resistance RR0306, RR0510, RR0816, RR1220 E-24: 3 digit,
RR0306, RR0510, RR0816, RR1220 E-96: 4 digit,

only given to 3 digit coders
for RR0816 E-96 series

Letter M is added for RR1220 E-96 series 4digit codes

Resistance tolerance

◆ Electrical Specification

Type	Power ratings	Temperature coefficient of resistance (ppm/°C)	Resistance range(Ω) Resistance tolerance			Maximum voltage	Resistance value series	Operating temperature	Packaging quantity
			±0.1% (B)	±0.5% (D)	±1% (F)				
RR0306	1/20W	±25(P)	33≤R≤22k			15V	E-24	-55°C ~ 125°C	5,000pcs
		±100(R)	—	—	10≤R≤30				
RR0510	1/16W	±25(P)	—	100≤R≤100k	—	25V	E-24, E-96	-55°C ~ 125°C	10,000pcs
		±100(R)	—	10≤R<100	—				
RR0816	1/16W	±25(P)	—	100≤R≤360k	—	75V	E-24, E-96	-55°C ~ 125°C	5,000pcs
		±50(Q)	—	10≤R<100	—				
RR1220	1/10W	±25(P)	—	100≤R≤1M		100V	E-24, E-96	-55°C ~ 125°C	5,000pcs
		±50(Q)	—	10≤R<100	—				

◆ Dimensions

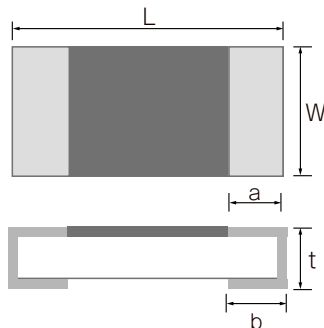

Type	Size (inch)	L	W	a	b	t
RR0306	0201	0.60±0.05	0.30±0.05	0.12±0.05	0.12±0.05	0.23±0.03
RR0510	0402	1.00±0.05	0.50±0.05	0.20±0.10	0.25±0.05	0.35±0.05
RR0816	0603	1.60±0.20	0.80±0.20	0.30±0.20	0.30±0.20	0.40±0.10
RR1220	0805	2.00±0.20	1.25±0.20	0.40±0.20	0.40±0.20	0.40±0.10

(unit : mm)

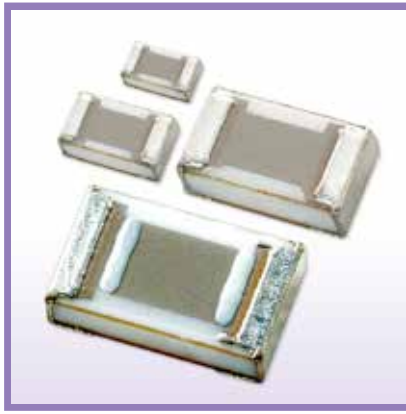

Metal thin film trimmable chip resistors

■ RT series

AEC-Q200 Compliant

Features

- Patented trimming method (Patent# 1921853) guarantees precision trimming, post trimming stability and short trimming time.
- Available as small as 0.3mm x 0.6mm

Applications

- Sensor circuits that require accuracy (e.g. automotive electronics)
- PA module of mobile phone
- Devices that requires anti-vibration stability (e.g. microphone)

Thin film surface mount resistors

RT series



◆ Part numbering system

RT 0816 P - 102 - M

Series code		Resistance tolerance
Size: RT0603, RT0510, RT0816, RT1220	Temperature coefficient of resistance	Nominal resistance value

◆ Electrical Specification

Type	Power ratings	Temperature coefficient of resistance (ppm/°C)	Initial resistance value (Ω)				Initial resistance value tolerance (%)	Maximum voltage	Operating temperature	Packaging quantity
			Targetted resistance value (Ω)							
RT0603	1/20W	±25(P)	150	330	-	-	±20(M)	15V	-55°C ~ 125°C	15,000pcs
			1.0k	1.9k	-	-				
		±100(R)	1.5k	-	-	-		25V		
			10k	-	-	-				
RT0510	1/16W	±25(P)	100	270	-	-		75V		10,000pcs
			820	2.1k	-	-				
		±100(R)	1.5k	-	-	-				
			10k	-	-	-				
RT0816	1/16W	±25(P)	100	330	1.0k	-	100V	5,000pcs		
			2.7k	8.0k	8.8k	-				
		±100(R)	-	3.3k	10k	--				
			-	37k	40k	-				
RT1220	1/10W	±25(P)	100	330	1.0k	-	5,000pcs			
			8.2k	15k	15k	-				
		±50(Q)	33	-	-	-				
			4.7k	-	-	-				
		±100(R)	3.3k	10k	33k	100k				
			100k	120k	120k	220k				

◆ Dimensions

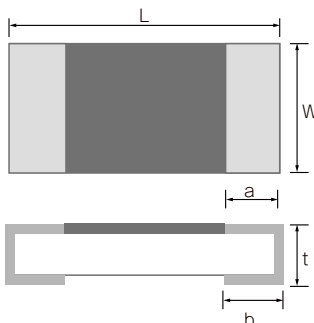

Type	Size (inch)	L	W	a	b	t
RT0603	0201	0.60±0.05	0.30±0.03	0.12±0.05	0.15±0.05	0.25±0.03
RT0510	0402	1.00±0.07	0.50±0.07	0.20±0.10	0.25±0.20	0.35±0.05
RT0816	0603	1.60±0.20	0.80±0.20	0.30±0.20	0.30±0.20	0.40±0.10
RT1220	0805	2.00±0.20	1.25±0.20	0.40±0.20	0.40±0.20	0.40±0.10

(unit : mm)

Metal thin film chip resistor networks

■ RM series

AEC-Q200 Compliant

Features

- Relative resistance tolerance and relative TCR definable among multiple resistors within package.
- Relative resistance tolerance: $\pm 0.01\%$, relative TCR: $\pm 1\text{ppm}/^\circ\text{C}$
- Number of resistors in package: 2 or higher, standard and custom circuits designs available
- RG series equivalent reliability and long term stability: less than $\pm 0.1\%$ drift after 10000 hour stress test.
- RoHS compliant, 100% lead free

Applications

- Precision measurement instrumentation, medical electronics, automotive electronics
- Voltage divider and amplification circuits that require very precise relative resistance tolerance and TCR
- Multi step precision amplification circuits for minute signals

◆ Part numbering system

RM 2012 A - */** - P W X L 10**

Series code

Size: RM2012, RM3216, RM3225

circuits

Nominal Resistance Value(R1/R2)

Absolute TCR

Relative resistance tolerance

Relative TCR

Absolute resistance tolerance

Packaging quantity:
10(1,000pcs), 50(5,000pcs)

RM 3216 C - ** - 10

Series code

Size: RM3216, RM3225, RM6432

circuits

Custom part number (e.g.)N10

Packaging quantity:
10(1,000pcs), 50(5,000pcs)

※ Please contact our sales office regarding custom products including resistance, resistance combination, number of elements, circuit, and others.

※ Standard quantity / reel is 1000 and 5000. Please contact our sales office for custom product's quantity / reel.

※ Standard resistance value pairings are shown as below
(Standard products are 2element circuit typeA & typeB only.)

◆ Standard resistance value pairings

Ratio	R1 (Ω)	R2 (Ω)	Ratio	R1 (Ω)	R2 (Ω)	Ratio	R1 (Ω)	R2 (Ω)	Ratio	R1 (Ω)	R2 (Ω)	Ratio	R1 (Ω)	R2 (Ω)	Ratio	R1 (Ω)	R2 (Ω)
1 : 1	1k	1k	1 : 3	1k	3k	1 : 5	1k	5k	1 : 9	1k	9k	1 : 20	1k	20k	1 : 50	1K	50k
	10k	10k		10k	30k		2k	10k		10k	90k		2k	40k		2K	100k
	100k	100k		100k	300k		10k	50k		1k	10k		5k	100k		1K	100k
1 : 2	1k	2k	1 : 4	1k	4k	1 : 6	1k	6k	1 : 10	2k	20k	1 : 25	1k	25k	1 : 100	2K	200k
	10k	20k		10k	40k		10k	60k		10k	100k		2k	50k			
	100k	200k															

◆ Electrical Specification

○ 4 terminal, 2 element



Type	Power ratings (85°C)	Resistance range (Ω)	Resistance tolerance (Code)				Temperature coefficient of resistance (Code)				Packaging quantity (designation)
			Absolute tolerance	Tolerance ratio *1			Absolute TCR	TCR tracking *1			
				Resistance ratio = 1	1 < Resistance ratio ≤ 100	100 < Resistance ratio ≤ 500		Resistance ratio = 1	1 < Resistance ratio ≤ 100	100 < Resistance ratio ≤ 500	
RM2012	0.05W / Element 0.1W / Package	100 ~ <300	±0.1%(B) ±0.5%(D)	±0.02%(P) ±0.05%(W) ±0.1%(B) ±0.5%(D)	±0.05%(W) ±0.1%(B) ±0.5%(D)	-	±10ppm/°C(N) ±25ppm/°C(P)	±1ppm/°C(X) ±2ppm/°C(W) ±5ppm/°C(V)	±2ppm/°C(W) ±5ppm/°C(V)	-	tape & reel (T&R) 10=1,000pcs 50=5,000pcs
		300 ~ 100k	±0.05%(W) ±0.1%(B) ±0.5%(D)	±0.01%(L) ±0.02%(P) ±0.05%(W) ±0.1%(B) ±0.5%(D)	±0.05%(W) ±0.1%(B) ±0.5%(D)	±0.05%(W) ±0.1%(B) ±0.5%(D)	±5ppm/°C(V) ±10ppm/°C(N) ±25ppm/°C(P)	±1ppm/°C(X) ±2ppm/°C(W) ±5ppm/°C(V)	±1ppm/°C(X) ±2ppm/°C(W) ±5ppm/°C(V)	±2ppm/°C(W) ±5ppm/°C(V)	
RM3216	0.063W / Element 0.125W / Package	100 ~ <300	±0.1%(B) ±0.5%(D)	±0.02%(P) ±0.05%(W) ±0.1%(B) ±0.5%(D)	±0.05%(W) ±0.1%(B) ±0.5%(D)	-	±10ppm/°C(N) ±25ppm/°C(P)	±1ppm/°C(X) ±2ppm/°C(W) ±5ppm/°C(V)	±2ppm/°C(W) ±5ppm/°C(V)	-	
		300 ~ 500k	±0.05%(W) ±0.1%(B) ±0.5%(D)	±0.01%(L) ±0.02%(P) ±0.05%(W) ±0.1%(B) ±0.5%(D)	±0.05%(W) ±0.1%(B) ±0.5%(D)	±0.05%(W) ±0.1%(B) ±0.5%(D)	±5ppm/°C(V) ±10ppm/°C(N) ±25ppm/°C(P)	±1ppm/°C(X) ±2ppm/°C(W) ±5ppm/°C(V)	±1ppm/°C(X) ±2ppm/°C(W) ±5ppm/°C(V)	±2ppm/°C(W) ±5ppm/°C(V)	
RM3225	0.1W / Element 0.2W / Package	100 ~ <300	±0.1%(B) ±0.5%(D)	±0.02%(P) ±0.05%(W) ±0.1%(B) ±0.5%(D)	±0.05%(W) ±0.1%(B) ±0.5%(D)	-	±10ppm/°C(N) ±25ppm/°C(P)	±1ppm/°C(X) ±2ppm/°C(W) ±5ppm/°C(V)	±2ppm/°C(W) ±5ppm/°C(V)	-	
		300 ~ 500k	±0.05%(W) ±0.1%(B) ±0.5%(D)	±0.01%(L) ±0.02%(P) ±0.05%(W) ±0.1%(B) ±0.5%(D)	±0.05%(W) ±0.1%(B) ±0.5%(D)	±0.05%(W) ±0.1%(B) ±0.5%(D)	±5ppm/°C(V) ±10ppm/°C(N) ±25ppm/°C(P)	±1ppm/°C(X) ±2ppm/°C(W) ±5ppm/°C(V)	±1ppm/°C(X) ±2ppm/°C(W) ±5ppm/°C(V)	±2ppm/°C(W) ±5ppm/°C(V)	

*1 Contact us for detailed information on relative tolerance and TCR.

○ 4 terminal, 3 element



○ 6 terminal, 3 element



Type	Power rating (85°C)	Resistance range (Ω)	Resistance tolerance (Code)				Temperature coefficient of resistance (Code)				Packaging quantity (designation)
			Absolute tolerance	Tolerance ratio *1			Absolute TCR	TCR tracking *1			
				Resistance ratio = 1	1 < Resistance ratio ≤ 100	100 < Resistance ratio ≤ 500		Resistance ratio = 1	1 < Resistance ratio ≤ 100	100 < Resistance ratio ≤ 500	
RM3216	0.042W / Element 0.125W / Package	100 ~ <300	±0.1%(B) ±0.5%(D)	±0.02%(P) ±0.05%(W) ±0.1%(B) ±0.5%(D)	±0.05%(W) ±0.1%(B) ±0.5%(D)	-	±10ppm/°C(N) ±25ppm/°C(P)	±1ppm/°C(X) ±2ppm/°C(W) ±5ppm/°C(V)	±2ppm/°C(W) ±5ppm/°C(V)	-	tape & reel (T&R) 10=1,000pcs 50=5,000pcs
		300 ~ 100k	±0.05%(W) ±0.1%(B) ±0.5%(D)	±0.01%(L) ±0.02%(P) ±0.05%(W) ±0.1%(B) ±0.5%(D)	±0.05%(W) ±0.1%(B) ±0.5%(D)	±0.05%(W) ±0.1%(B) ±0.5%(D)	±5ppm/°C(V) ±10ppm/°C(N) ±25ppm/°C(P)	±1ppm/°C(X) ±2ppm/°C(W) ±5ppm/°C(V)	±1ppm/°C(X) ±2ppm/°C(W) ±5ppm/°C(V)	±2ppm/°C(W) ±5ppm/°C(V)	
RM3225	0.066W / Element 0.2W / Package	100 ~ <300	±0.1%(B) ±0.5%(D)	±0.02%(P) ±0.05%(W) ±0.1%(B) ±0.5%(D)	±0.05%(W) ±0.1%(B) ±0.5%(D)	-	±10ppm/°C(N) ±25ppm/°C(P)	±1ppm/°C(X) ±2ppm/°C(W) ±5ppm/°C(V)	±2ppm/°C(W) ±5ppm/°C(V)	-	
		300 ~ 100k	±0.05%(W) ±0.1%(B) ±0.5%(D)	±0.01%(L) ±0.02%(P) ±0.05%(W) ±0.1%(B) ±0.5%(D)	±0.05%(W) ±0.1%(B) ±0.5%(D)	±0.05%(W) ±0.1%(B) ±0.5%(D)	±5ppm/°C(V) ±10ppm/°C(N) ±25ppm/°C(P)	±1ppm/°C(X) ±2ppm/°C(W) ±5ppm/°C(V)	±1ppm/°C(X) ±2ppm/°C(W) ±5ppm/°C(V)	±2ppm/°C(W) ±5ppm/°C(V)	

*1 Contact us for detailed information on relative tolerance and TCR.

Thin film surface mount resistors

RM series

Metal thin film chip resistor networks

RM series

6 terminal, 4 element



Type	Power ratings (85°C)	Resistance range (Ω)	Resistance tolerance (Code)				Temperature coefficient of resistance (Code)				Packaging quantity (designation)
			Absolute tolerance	Tolerance ratio *1			Absolute TCR	TCR tracking *1			
				Resistance ratio =1	1< Resistance ratio ≤100	100< Resistance ratio ≤500		Resistance ratio =1	1< Resistance ratio ≤100	100< Resistance ratio ≤500	
RM3216	0.032W / Element 0.125W / Package	100 ~<300	±0.1%(B) ±0.5%(D)	±0.02%(P) ±0.05%(W) ±0.1%(B) ±0.5%(D)	±0.05%(W) ±0.1%(B) ±0.5%(D)	-	±10ppm/°C(N) ±25ppm/°C(P)	±1ppm/°C(X) ±2ppm/°C(W) ±5ppm/°C(V)	±2ppm/°C(W) ±5ppm/°C(V)	-	tape & reel (T&R)
		300 ~ 100k	±0.05%(W) ±0.1%(B) ±0.5%(D)	±0.01%(L) ±0.02%(P) ±0.05%(W) ±0.1%(B) ±0.5%(D)	±0.05%(W) ±0.1%(B) ±0.5%(D)	±5ppm/°C(V) ±10ppm/°C(N) ±25ppm/°C(P)	±1ppm/°C(X) ±2ppm/°C(W) ±5ppm/°C(V)	±1ppm/°C(X) ±2ppm/°C(W) ±5ppm/°C(V)	±2ppm/°C(W) ±5ppm/°C(V)		
RM3225	0.05W / Element 0.2W / Package	100 ~<300	±0.1%(B) ±0.5%(D)	±0.02%(P) ±0.05%(W) ±0.1%(B) ±0.5%(D)	±0.05%(W) ±0.1%(B) ±0.5%(D)	-	±10ppm/°C(N) ±25ppm/°C(P)	±1ppm/°C(X) ±2ppm/°C(W) ±5ppm/°C(V)	±2ppm/°C(W) ±5ppm/°C(V)	-	10=1,000pcs 50=5,000pcs
		300 ~ 100k	±0.05%(W) ±0.1%(B) ±0.5%(D)	±0.01%(L) ±0.02%(P) ±0.05%(W) ±0.1%(B) ±0.5%(D)	±0.05%(W) ±0.1%(B) ±0.5%(D)	±5ppm/°C(V) ±10ppm/°C(N) ±25ppm/°C(P)	±1ppm/°C(X) ±2ppm/°C(W) ±5ppm/°C(V)	±1ppm/°C(X) ±2ppm/°C(W) ±5ppm/°C(V)	±2ppm/°C(W) ±5ppm/°C(V)		

*1 Contact us for detailed information on relative tolerance and TCR.

8 terminal, 4 element



Type	Power ratings (85°C)	Resistance range (Ω)	Resistance tolerance (Code)				Temperature coefficient of resistance (Code)				Packaging quantity (designation)
			Absolute tolerance	Tolerance ratio *1			Absolute TCR	TCR tracking *1			
				Resistance ratio =1	1< Resistance ratio ≤100	100< Resistance ratio ≤500		Resistance ratio =1	1< Resistance ratio ≤100	100< Resistance ratio ≤500	
RM3216	0.032W / Element 0.125W / Package	100 ~<300	±0.1%(B) ±0.5%(D)	±0.02%(P) ±0.05%(W) ±0.1%(B) ±0.5%(D)	±0.05%(W) ±0.1%(B) ±0.5%(D)	-	±10ppm/°C(N) ±25ppm/°C(P)	±1ppm/°C(X) ±2ppm/°C(W) ±5ppm/°C(V)	±2ppm/°C(W) ±5ppm/°C(V)	-	tape & reel (T&R)
		300 ~ 100k	±0.05%(W) ±0.1%(B) ±0.5%(D)	±0.01%(L) ±0.02%(P) ±0.05%(W) ±0.1%(B) ±0.5%(D)	±0.05%(W) ±0.1%(B) ±0.5%(D)	±5ppm/°C(V) ±10ppm/°C(N) ±25ppm/°C(P)	±1ppm/°C(X) ±2ppm/°C(W) ±5ppm/°C(V)	±1ppm/°C(X) ±2ppm/°C(W) ±5ppm/°C(V)	±2ppm/°C(W) ±5ppm/°C(V)		
RM3225	0.05W / Element 0.2W / Package	100 ~<300	±0.1%(B) ±0.5%(D)	±0.02%(P) ±0.05%(W) ±0.1%(B) ±0.5%(D)	±0.05%(W) ±0.1%(B) ±0.5%(D)	-	±10ppm/°C(N) ±25ppm/°C(P)	±1ppm/°C(X) ±2ppm/°C(W) ±5ppm/°C(V)	±2ppm/°C(W) ±5ppm/°C(V)	-	10=1,000pcs 50=5,000pcs
		300 ~ 100k	±0.05%(W) ±0.1%(B) ±0.5%(D)	±0.01%(L) ±0.02%(P) ±0.05%(W) ±0.1%(B) ±0.5%(D)	±0.05%(W) ±0.1%(B) ±0.5%(D)	±5ppm/°C(V) ±10ppm/°C(N) ±25ppm/°C(P)	±1ppm/°C(X) ±2ppm/°C(W) ±5ppm/°C(V)	±1ppm/°C(X) ±2ppm/°C(W) ±5ppm/°C(V)	±2ppm/°C(W) ±5ppm/°C(V)		
RM6432	0.1W / Element 0.4W / Package	100 ~<300	±0.1%(B) ±0.5%(D)	±0.02%(P) ±0.05%(W) ±0.1%(B) ±0.5%(D)	±0.05%(W) ±0.1%(B) ±0.5%(D)	-	±10ppm/°C(N) ±25ppm/°C(P)	±1ppm/°C(X) ±2ppm/°C(W) ±5ppm/°C(V)	±2ppm/°C(W) ±5ppm/°C(V)	-	tape & reel (T&R)
		300 ~ 1M	±0.05%(W) ±0.1%(B) ±0.5%(D)	±0.01%(L) ±0.02%(P) ±0.05%(W) ±0.1%(B) ±0.5%(D)	±0.05%(W) ±0.1%(B) ±0.5%(D)	±5ppm/°C(V) ±10ppm/°C(N) ±25ppm/°C(P)	±1ppm/°C(X) ±2ppm/°C(W) ±5ppm/°C(V)	±1ppm/°C(X) ±2ppm/°C(W) ±5ppm/°C(V)	±2ppm/°C(W) ±5ppm/°C(V)		

*1 Contact us for detailed information on relative tolerance and TCR.

○ 8 terminal, 6 element



Type	Power ratings (85°C)	Resistance range (Ω)	Resistance tolerance (Code)				Temperature coefficient of resistance (Code)				Packaging quantity (designation)
			Absolute tolerance	Tolerance ratio ^{*1}			Absolute TCR	TCR tracking ^{*1}			
				Resistance ratio = 1	1 < Resistance ratio ≤ 100	100 < Resistance ratio ≤ 500		Resistance ratio = 1	1 < Resistance ratio ≤ 100	100 < Resistance ratio ≤ 500	
RM3216	0.021W / Element 0.125W / Package	100 ~ <300	±0.1%(B) ±0.5%(D)	±0.02%(P) ±0.05%(W) ±0.1%(B) ±0.5%(D)	±0.05%(W) ±0.1%(B) ±0.5%(D)	-	±10ppm/°C(N) ±25ppm/°C(P)	±1ppm/°C(X) ±2ppm/°C(W) ±5ppm/°C(V)	±2ppm/°C(W) ±5ppm/°C(V)	-	tape & reel (T&R) 10=1,000pcs 50=5,000pcs
		300 ~ 100k	±0.05%(W) ±0.1%(B) ±0.5%(D)	±0.01%(L) ±0.02%(P) ±0.05%(W) ±0.1%(B) ±0.5%(D)	±0.05%(W) ±0.1%(B) ±0.5%(D)	±5ppm/°C(V) ±10ppm/°C(N) ±25ppm/°C(P)	±1ppm/°C(X) ±2ppm/°C(W) ±5ppm/°C(V)	±1ppm/°C(X) ±2ppm/°C(W) ±5ppm/°C(V)	±2ppm/°C(W) ±5ppm/°C(V)		
RM3225	0.033W / Element 0.2W / Package	100 ~ <300	±0.1%(B) ±0.5%(D)	±0.02%(P) ±0.05%(W) ±0.1%(B) ±0.5%(D)	±0.05%(W) ±0.1%(B) ±0.5%(D)	-	±10ppm/°C(N) ±25ppm/°C(P)	±1ppm/°C(X) ±2ppm/°C(W) ±5ppm/°C(V)	±2ppm/°C(W) ±5ppm/°C(V)	-	
		300 ~ 100k	±0.05%(W) ±0.1%(B) ±0.5%(D)	±0.01%(L) ±0.02%(P) ±0.05%(W) ±0.1%(B) ±0.5%(D)	±0.05%(W) ±0.1%(B) ±0.5%(D)	±5ppm/°C(V) ±10ppm/°C(N) ±25ppm/°C(P)	±1ppm/°C(X) ±2ppm/°C(W) ±5ppm/°C(V)	±1ppm/°C(X) ±2ppm/°C(W) ±5ppm/°C(V)	±2ppm/°C(W) ±5ppm/°C(V)		
RM6432	0.066W / Element 0.4W / Package	100 ~ <300	±0.1%(B) ±0.5%(D)	±0.02%(P) ±0.05%(W) ±0.1%(B) ±0.5%(D)	±0.05%(W) ±0.1%(B) ±0.5%(D)	-	±10ppm/°C(N) ±25ppm/°C(P)	±1ppm/°C(X) ±2ppm/°C(W) ±5ppm/°C(V)	±2ppm/°C(W) ±5ppm/°C(V)	-	
		300 ~ 1M	±0.05%(W) ±0.1%(B) ±0.5%(D)	±0.01%(L) ±0.02%(P) ±0.05%(W) ±0.1%(B) ±0.5%(D)	±0.05%(W) ±0.1%(B) ±0.5%(D)	±5ppm/°C(V) ±10ppm/°C(N) ±25ppm/°C(P)	±1ppm/°C(X) ±2ppm/°C(W) ±5ppm/°C(V)	±1ppm/°C(X) ±2ppm/°C(W) ±5ppm/°C(V)	±2ppm/°C(W) ±5ppm/°C(V)		

*1 Contact us for detailed information on relative tolerance and TCR.

○ Some examples of custom RM series

RM2525(2.5mm × 2.5mm)



RM5882(5.8mm × 8.2mm)

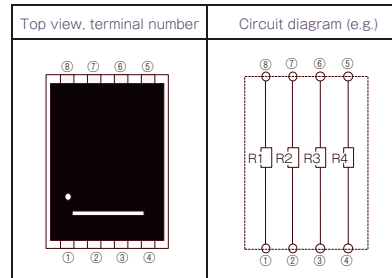

RM10280(10.2mm × 7.2mm)



RM8258(8.2mm × 5.8mm)

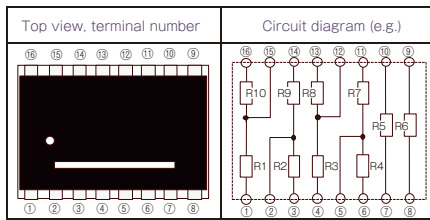

RM11264(11.2mm × 6.4mm)

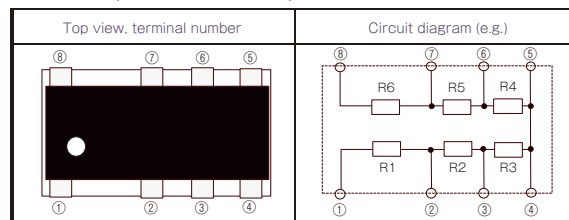

RM5050(5.0mm × 5.0mm)

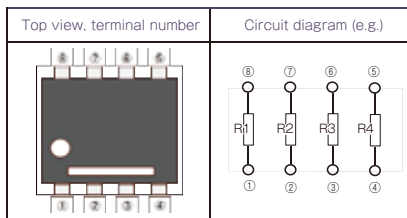

Thin film surface mount resistors
RM series

Metal thin film chip resistor networks

RM series

Dimensions

Thin film surface mount resistors



RM series

4 terminal								
Type	Size (inch)	L	W	t	a	b	W1	W2
RM2012	0805	2.00±0.20	1.25±0.20	0.45±0.10	0.50±0.20	0.60±0.20	0.40±0.20	0.35±0.20
RM3216	1206	3.20±0.20	1.60±0.20	0.45±0.10	1.00±0.25	1.00±0.20	0.40±0.25	0.40±0.20
RM3225	1209	3.20±0.20	2.50±0.20	0.45±0.10	1.00±0.25	1.00±0.20	0.40±0.25	0.60±0.20

(unit : mm)

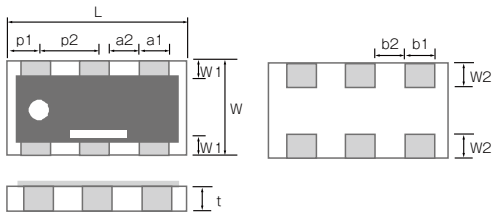

6 terminal												
Type	Size (inch)	L	W	t	a1	a2	b1	b2	p1	p2	W1	W2
RM3216	1206	3.20±0.20	1.60±0.20	0.45±0.10	0.50±0.20	0.45±0.20	0.50±0.20	0.45±0.20	0.63±0.20	0.95±0.10	0.23±0.20	0.40±0.20
RM3225	1209	3.20±0.20	2.50±0.20	0.45±0.10	0.50±0.10	0.45±0.10	0.50±0.10	0.45±0.10	0.63±0.20	0.95±0.10	0.30±0.20	0.50±0.20

(unit : mm)

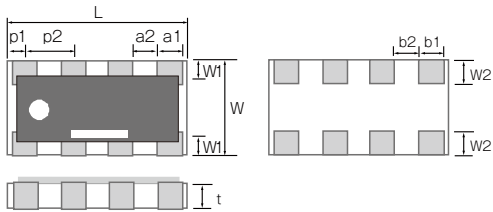

8 terminal												
Type	Size (inch)	L	W	t	a1	a2	b1	b2	p1	p2	W1	W2
RM3216	1206	3.20±0.20	1.60±0.20	0.45±0.10	0.40±0.20	0.40±0.20	0.40±0.20	0.40±0.20	0.40±0.20	0.80±0.10	0.30±0.20	0.40±0.20
RM3225	1209	3.20±0.20	2.50±0.20	0.45±0.10	0.40 +0.20/-0.10	0.40 +0.10/-0.20	0.40 +0.10/-0.20	0.40 +0.10/-0.20	0.40±0.20	0.80±0.10	0.30±0.20	0.40±0.20
RM6432	2512	6.40±0.20	3.20±0.20	0.50±0.10	0.66 +0.20/-0.10	0.94 +0.10/-0.20	0.66 +0.20/-0.10	0.94 +0.10/-0.20	0.80±0.20	1.60±0.10	0.50±0.20	0.60±0.10

(unit : mm)

◆ Reliability specification

Test items	Condition (test methods (MIL-PRF-55342/JIS C5201-1))	Standard	
		Absolute tolerance	Relative tolerance
Short time overload	2.5 x rated voltage,*1 5seconds	±(0.05%+0.01Ω)	±0.02%
Life (biased)	85°C, rated voltage,*1 90min on 30min off, 1000hours	±(0.05%+0.01Ω)	±0.02%
High temperature high humidity	85°C, 85%RH, 1/10 of rated power, 90min on 30min off, 1000hours	±(0.05%+0.01Ω)	±0.02%
Temperature shock	-55°C (38min) ~ 125°C (30min) 1000cycles*2	±(0.05%+0.01Ω)	±0.02%
High temperature exposure	155°C, no bias, 100hours	±(0.05%+0.01Ω)	±0.02%
Resistance to soldering heat	260±5°C, 10 seconds (reflow)	±(0.05%+0.01Ω)	±0.02%

*1 Rated voltage is given by $E = \sqrt{R \times P}$

E= rated voltage (V), R=nominal resistance value(Ω), P=rated power(W)

If rated voltage exceeds maximum voltage /element, maximum voltage/element is the rated voltage.

*2 Based on the tests done on RM316.RM3225.

Please contact our sales office for other or custom dimensional products

Metal thin film chip resistor networks

RM series

Reliability test data

Thin film surface mount resistors

RM series

Load life with rated power @85°C

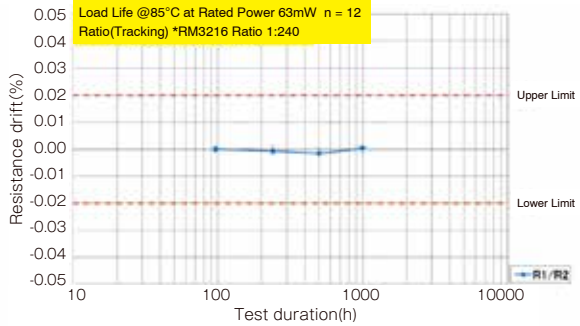
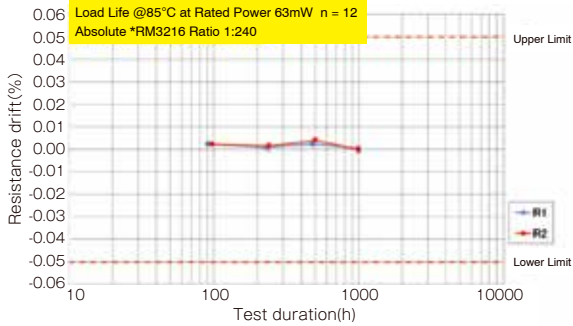

High temperature high humidity (biased)

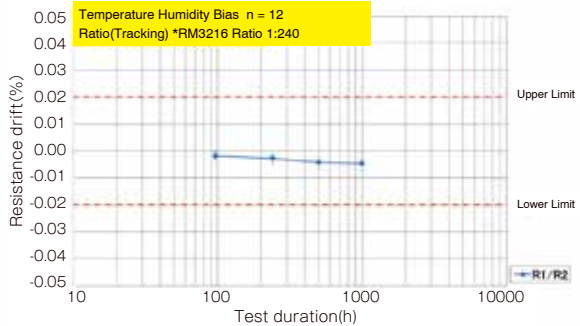
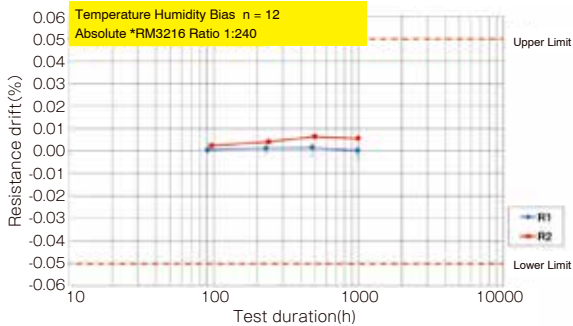

Temperature shock

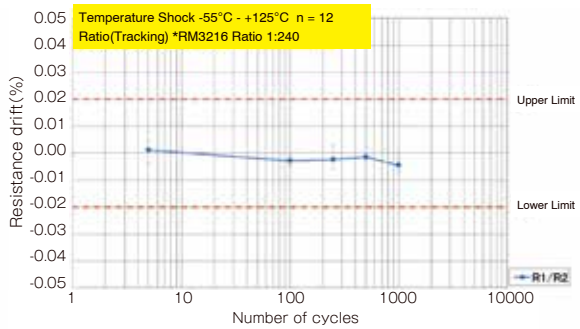

High temperature exposure (155°C)

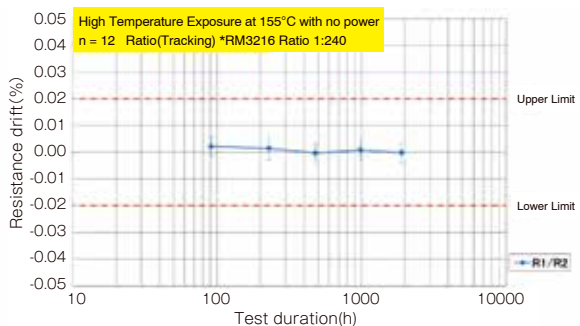
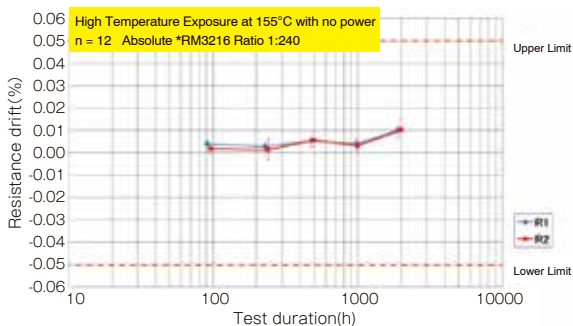

◆TCR linearity

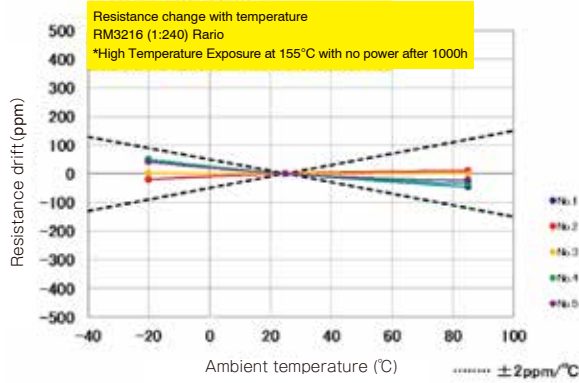
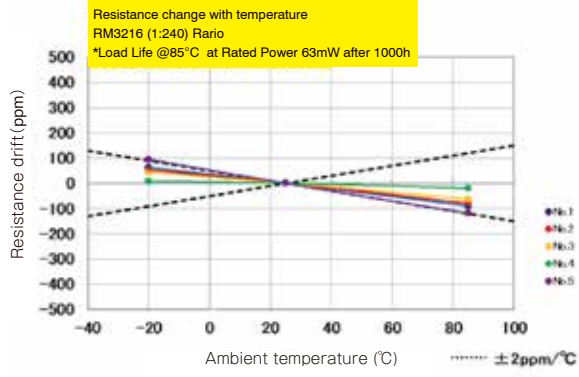

Thin film surface mount resistors

RM series

◆Derating Curve

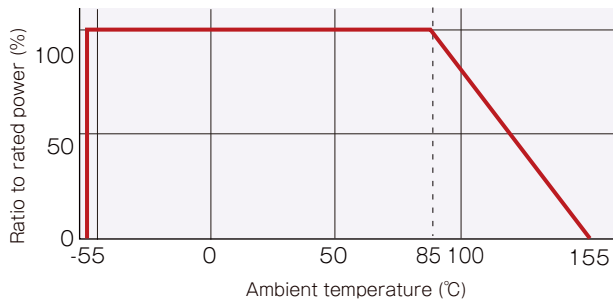

High temperature metal thin film resistor networks

■ RMA series

AEC-Q200 Compliant

Features

- Conductive epoxy compatible chip resistor network
- Relative resistance tolerance: $\pm 0.01\%$, relative TCR: $\pm 1\text{ppm}/^\circ\text{C}$
- Operating temperature up to 230°C
- RoHS compliant, 100% lead free (gold terminal)
- Thin film structure enabling low noise and anti-sulfur

Applications

- Automotive electronics
- High temperature electronic devices
- Downhole drilling

Thin film surface mount resistors

RMA series

◆ Part numbering system

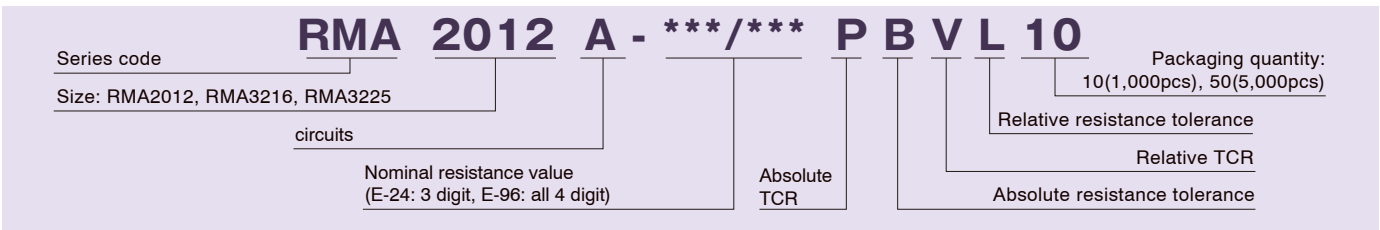

◆ Electrical Specification

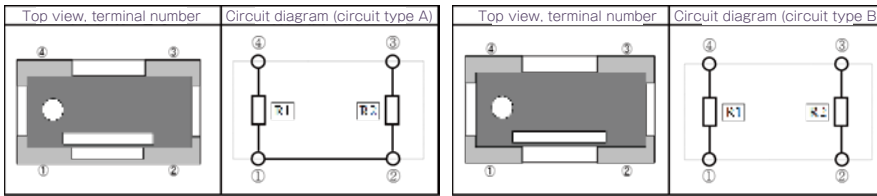

Type	Power ratings (85°C)	Resistance range (Ω)	Resistance tolerance (Code)				Temperature coefficient of resistance (Code)				Packaging quantity (designation)
			Absolute tolerance	Tolerance ratio		Absolute TCR	TCR tracking				
				Resistance ratio = 1	1 < Resistance ratio ≤ 100		100 < Resistance ratio ≤ 500	Resistance ratio = 1	1 < Resistance ratio ≤ 100	100 < Resistance ratio ≤ 500	
RMA2012	0.05W / Element 0.1W / Package	100 ~ <300	±0.1%(B) ±0.5%(D)	±0.02%(P) ±0.05%(W) ±0.1%(B) ±0.5%(D)	±0.05%(W) ±0.1%(B) ±0.5%(D)	-	±10ppm/°C(N) ±25ppm/°C(P)	±1ppm/°C(X) ±2ppm/°C(W) ±5ppm/°C(V)	±2ppm/°C(W) ±5ppm/°C(V)	-	tape & reel (T&R) 10=1,000pcs 50=5,000pcs
		300 ~ 100k	±0.05%(W) ±0.1%(B) ±0.5%(D)	±0.01%(L) ±0.02%(P) ±0.05%(W) ±0.1%(B) ±0.5%(D)	±0.05%(W) ±0.1%(B) ±0.5%(D)	±5ppm/°C(V) ±10ppm/°C(N) ±25ppm/°C(P)	±1ppm/°C(X) ±2ppm/°C(W) ±5ppm/°C(V)	±1ppm/°C(X) ±2ppm/°C(W) ±5ppm/°C(V)	±2ppm/°C(W) ±5ppm/°C(V)		
RMA3216	0.063W / Element 0.125W / Package	100 ~ <300	±0.1%(B) ±0.5%(D)	±0.02%(P) ±0.05%(W) ±0.1%(B) ±0.5%(D)	±0.05%(W) ±0.1%(B) ±0.5%(D)	-	±10ppm/°C(N) ±25ppm/°C(P)	±1ppm/°C(X) ±2ppm/°C(W) ±5ppm/°C(V)	±2ppm/°C(W) ±5ppm/°C(V)	-	
		300 ~ 500k	±0.05%(W) ±0.1%(B) ±0.5%(D)	±0.01%(L) ±0.02%(P) ±0.05%(W) ±0.1%(B) ±0.5%(D)	±0.05%(W) ±0.1%(B) ±0.5%(D)	±5ppm/°C(V) ±10ppm/°C(N) ±25ppm/°C(P)	±1ppm/°C(X) ±2ppm/°C(W) ±5ppm/°C(V)	±1ppm/°C(X) ±2ppm/°C(W) ±5ppm/°C(V)	±2ppm/°C(W) ±5ppm/°C(V)		
RMA3225	0.1W / Element 0.2W / Package	100 ~ <300	±0.1%(B) ±0.5%(D)	±0.02%(P) ±0.05%(W) ±0.1%(B) ±0.5%(D)	±0.05%(W) ±0.1%(B) ±0.5%(D)	-	±10ppm/°C(N) ±25ppm/°C(P)	±1ppm/°C(X) ±2ppm/°C(W) ±5ppm/°C(V)	±2ppm/°C(W) ±5ppm/°C(V)	-	
		300 ~ 500k	±0.05%(W) ±0.1%(B) ±0.5%(D)	±0.01%(L) ±0.02%(P) ±0.05%(W) ±0.1%(B) ±0.5%(D)	±0.05%(W) ±0.1%(B) ±0.5%(D)	±5ppm/°C(V) ±10ppm/°C(N) ±25ppm/°C(P)	±1ppm/°C(X) ±2ppm/°C(W) ±5ppm/°C(V)	±1ppm/°C(X) ±2ppm/°C(W) ±5ppm/°C(V)	±2ppm/°C(W) ±5ppm/°C(V)		

◆ Dimensions

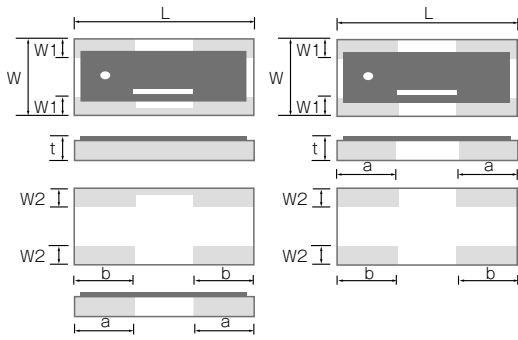

Type	Size (inch)	L	W	t	a	b	W1	W2
RMA2012	0805	2.0±0.2	1.25±0.2	0.45±0.1	0.5±0.2	0.6±0.2	0.4±0.2	0.35±0.2
RMA3216	1206	3.2±0.2	1.6±0.2	0.45±0.1	1.0±0.25	1.0±0.2	0.4±0.25	0.4±0.2
RMA3225	1209	3.2±0.2	2.5±0.2	0.45±0.1	1.0±0.25	1.0±0.2	0.4±0.25	0.6±0.2

(unit : mm)

Thin film surface mount resistors

RMA series

◆ Reliability specification

Test items	Condition (test methods (MIL-PRF-55342/JIS C5201-1))	Standard	
		absolute	relative
Short time overload	2.5 x rated voltage ^{*1} 5seconds	±(0.1%+0.01Ω)	±0.05%
Life (biased)	70°C, rated voltage, 90min on 30min off, 1000hours	±(0.1%+0.01Ω)	±0.05%
Temperature shock	85°C, 85%RH, 1/10 of rated power, 90min on 30min off, 1000hours	±(0.1%+0.01Ω)	±0.05%
High temperature exposure ^{*2}	-55°C (30min) ~ 125°C (30min)	±(0.1%+0.01Ω)	±0.05%
Resistance to soldering heat	155°C, no bias, 1000hours	±(0.1%+0.01Ω)	±0.05%

*1 Rated voltage is given by $E = \sqrt{R \times P}$ E= rated voltage (V), R=nominal resistance value(Ω), P=rated power(W)
If rated voltage exceeds maximum voltage /element, maximum voltage/element is the rated voltage.

*2 Please contact our sales office for details.

◆ Reliability test data

○ Biased life test

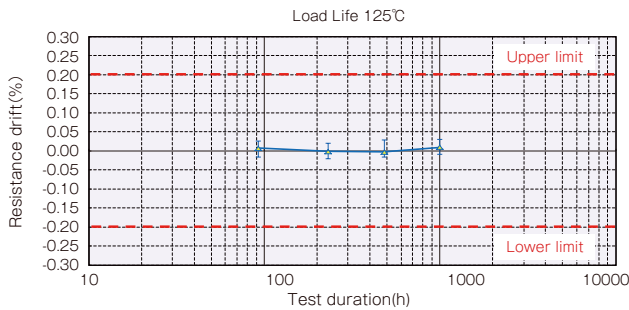

○ High temperature high humidity (biased)

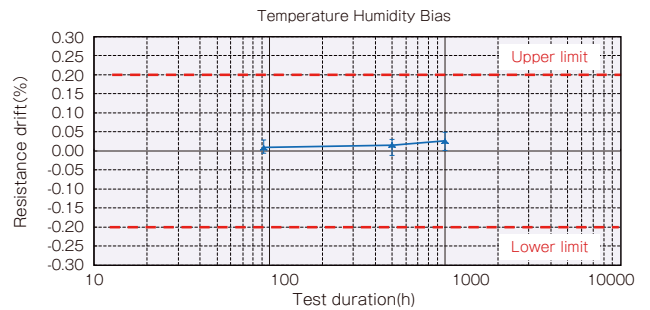

○ Temperature shock

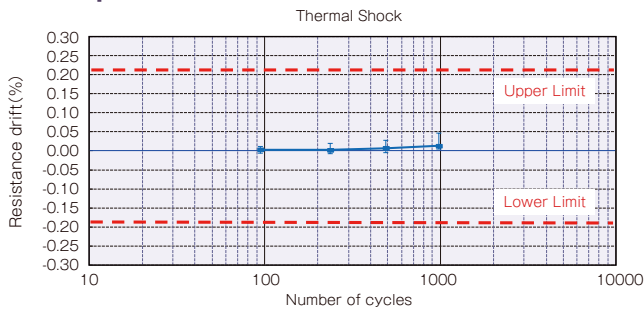

◆ Derating Curve

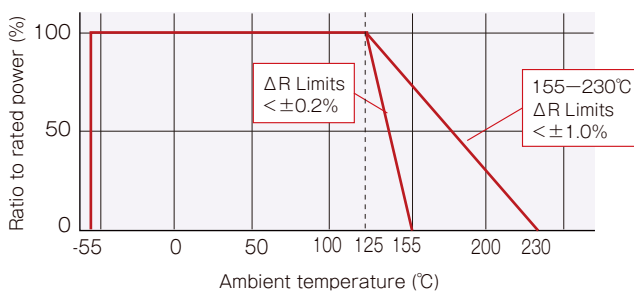

Resistors with radial leads

Radial lead metal thin film chip resistors

(the highest reliability and precision)

LRG series



Radial lead metal thin film chip resistors (the highest reliability and precision)

■ LRG series

Features

- Most reliable and the highest precision radial read thin film resistor
- The tightest resistance tolerance: +/-0.01%, the smallest temperature coefficient of resistance: ±1ppm/°C

Applications

- Industrial measurement, electrical scales
- High precision sensors, medical electronics



Resistors with radial leads

◆ Part numbering system

LRG 020 L - 1002 - L - T01



LRG series

◆ Electrical Specification

Type	Lead pitch (mm)	Power ratings	Temperature coefficient of resistance (ppm/°C)	Resistance range(Ω) Resistance tolerance				Maximum voltage	Resistance value series	Operating temperature	Packaging quantity
				±0.01% (L)	±0.02% (P)	±0.05% (W)	±0.5% (D)				
LRG020	5.08	0.3W	±1 (K) ±2 (L) ±5 (V)	100 ≤ R ≤ 100k				250V	E-24, E-96	-55°C ~ 125°C	100pcs

◆ Dimensions

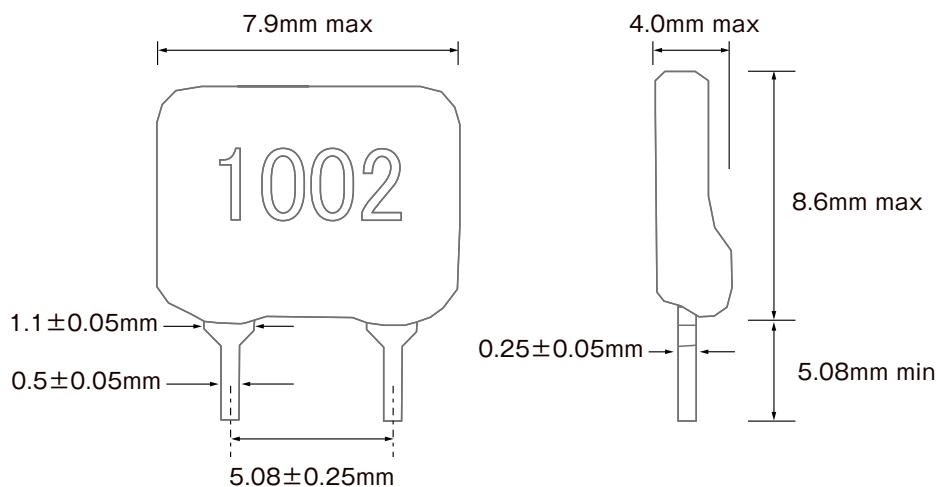

◆ Reliability specification

Test items	Condition (test methods (MIL-PRF-55342/JIS C5201-1))	Standard
Short time overload	2.5 x rated voltage,*1 5seconds	±0.05%+0.01Ω
Life (biased)	70°C, rated voltage,*1 90min on 30min off, 2000hours	±0.05%+0.01Ω
High temperature high humidity	85°C, 85%RH, 1/10 of rated power, 90min on 30min off, 2000hours	±0.05%+0.01Ω
Temperature shock	-65°C (15min) ~ 150°C (15min) 100cycles	±0.05%+0.01Ω
High temperature exposure	155°C, no bias, 1000hours	±0.05%+0.01Ω
Resistance to soldering heat	260±5°C, 10 seconds (reflow)	±0.05%+0.01Ω

*1 Rated voltage is given by $E = \sqrt{R \times P}$
 E= rated voltage (V), R=nominal resistance value(Ω), P=rated power(W)
 If rated voltage exceeds maximum voltage /element, maximum voltage/element is the rated voltage.

◆ Reliability test data

○ Biased life test

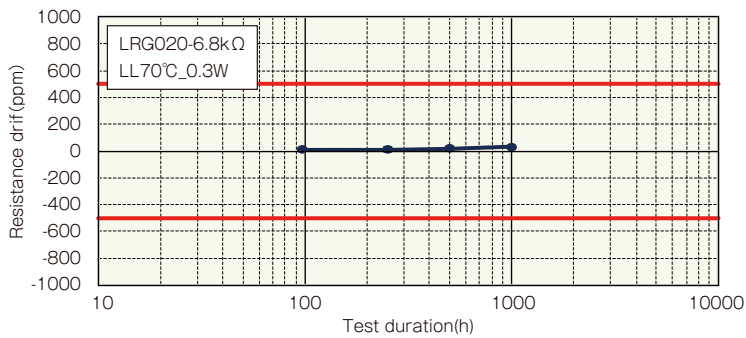

Resistors with radial leads
LRG series

◆ Derating Curve

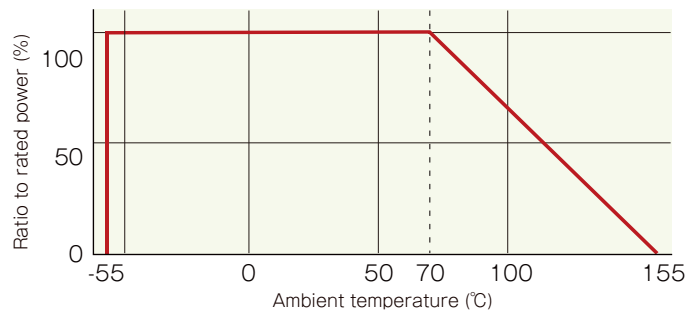

Current sensing surface mount resistors

Metal foil low resistance chip resistors

(long-side terminal)

KRL series

Metal foil low resistance chip resistors

(short-side terminal)

KRL series

Metal foil low resistance chip resistors

(4 terminal type)

KRL series

Precision low resistance chip resistors

SHR series

Low resistance chip resistors

(long-side terminal)

PRL / RL series

Low resistance chip resistors

(short-side terminal)

RL series

High Current chip jumpers

YJP series



Metal foil low resistance chip resistors (long-side terminal)

■ KRL series

AEC-Q200 Compliant

Features

- High current sensing long side terminal low resistance chip resistor
- Two types available: high temperature (operating temperature up to 175°C), low emf type (operating temperature up to 155°C)
- High current handling capability and wide range of power ratings
- Size: 1608 ~ 15075, power ratings: 0.5W ~ 10W, resistance value range: 1m ~ 500mΩ
- Face down construction. Choice between bottom only or wrap around terminal.



Applications

- Automotive electronics
- Power source devises, ACDC converters, DCDC converters
- Motors, inverters, office automation equipment

◆ Part numbering system

KRL 2012E - C - R010 - F - T1

Packaging quantity: T05 (500pcs)
T1 (1,000pcs), T5 (5,000pcs)

Series code

Size: KRL1608, KRL2012, KRL3216, KRL5025
KRL6432, KRL7638, KRL9045, KRL11050
KRL15075

Terminal type: D (bottom terminal), E (wrap around terminal)

Nominal resistance value

Resistance tolerance

Temperature characteristics type:
C (high operating temperature), M (low EMF)

◆ Electrical Specification

Type	Power ratings	Temperature coefficient of resistance (ppm/°C)	Resistance range(Ω) Resistance tolerance ^{*1}			Resistance value series	Operating temperature		Packaging quantity									
			±1% (F)	±2% (G)	±5% (J)		C	M										
KRL1608	0.5W	±50	10m≤R≤100m	—	—	E-6 ^{*2}	-55°C ~ 175°C	-55°C ~ 155°C	T5									
		±100	—	5m≤R≤9m	—													
KRL2012	1W	±50	3m≤R≤9m (1m step) 10m≤R≤500m	—	—				E-6 ^{*2}	-55°C ~ 175°C	-55°C ~ 155°C	T1						
		±100	—	R=2m	—													
		±150	—	—	R=1m													
KRL3216	1.5W	±50	3m≤R≤9m (1m step) 10m≤R≤500m	—	—							E-6 ^{*2}	-55°C ~ 175°C	-55°C ~ 155°C	T1			
		±100	—	R=2m	—													
		±150	—	—	R=1m													
KRL5025	2W	±50	3m≤R≤9m (1m step) 10m≤R≤500m	—	—										E-6 ^{*2}	-55°C ~ 175°C	-55°C ~ 155°C	T1
		±100	—	R=2m	—													
		±150	—	—	R=1m													
KRL6432	3W	±50	3m≤R≤9m (1m step) 10m≤R≤500m	—	—													E-6 ^{*2}
		±100	—	R=2m	—													
		±150	—	—	R=1m													
KRL7638	4W	±50	3m≤R≤9m (1m step) 10m≤R≤500m	—	—	E-6 ^{*2}	-55°C ~ 175°C	-55°C ~ 155°C	T1									
		±100	—	R=2m	—													
		±150	—	—	R=1m													
KRL9045	5W	±50	3m≤R≤9m (1m step) 10m≤R≤500m	—	—				E-6 ^{*2}	-55°C ~ 175°C	-55°C ~ 155°C	T1						
		±100	—	R=2m	—													
		±150	—	—	R=1m													
KRL11050	6W	±50	3m≤R≤9m (1m step) 10m≤R≤500m	—	—							E-6 ^{*2}	-55°C ~ 175°C	-55°C ~ 155°C	T1			
		±100	—	R=2m	—													
		±150	—	—	R=1m													
KRL15075	10W	±50	10m≤R≤500m	—	—										E-6 ^{*2}	-55°C ~ 175°C	-55°C ~ 155°C	T05
		±100	3m≤R≤9m (1m step)	R=2m	R=1m													
		±150	—	—	—													

*1 We can meet your requirement of less than 1mΩ. Please contact our sales office.

*2 We can meet your requirement of resistance value outside of E-6 series. Please contact our sales office.

◆ Dimensions

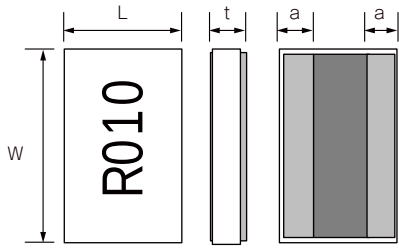

D Type

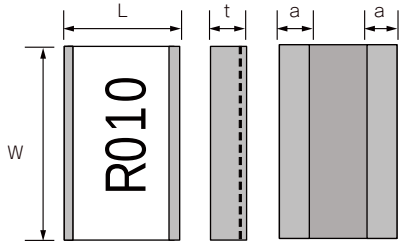

E Type

Type	Size (inch)	L	W	t	a
KRL1608 ^{*1}	0603	0.80±0.20	1.60±0.20	0.50±0.20	0.25±0.20(5mΩ~)
KRL2012	0805	1.25±0.20	2.00±0.20	0.50±0.20	0.30±0.20(2mΩ~)/0.55±0.20(1mΩ)
KRL3216	1206	1.60±0.20	3.20±0.20	0.50±0.20	0.30±0.20(2mΩ~)/0.55±0.20(1mΩ)
KRL5025	2010	2.50±0.20	5.00±0.20	0.50±0.20	0.55±0.20(2mΩ~)/0.90±0.20(1mΩ)
KRL6432	2512	3.10±0.20	6.30±0.20	0.50±0.20	0.50±0.20(2mΩ~)/1.20±0.20(1mΩ)
KRL7638	3015	3.80±0.20	7.60±0.20	0.50±0.20	0.60±0.20(2mΩ~)/1.35±0.20(1mΩ)
KRL9045	3518	4.50±0.20	9.00±0.20	0.50±0.20	0.70±0.20(2mΩ~)/1.60±0.20(1mΩ)
KRL11050	4320	5.00±0.20	11.00±0.20	0.50±0.20	0.80±0.20(2mΩ~)/1.60±0.20(1mΩ)
KRL15075	5930	7.50±0.20	15.00±0.20	0.65±0.20	1.10±0.20(2mΩ~)/2.75±0.20(1mΩ)

*1 KRL1608 doesn't have E Type

(unit : mm)

◆ Derating Curve

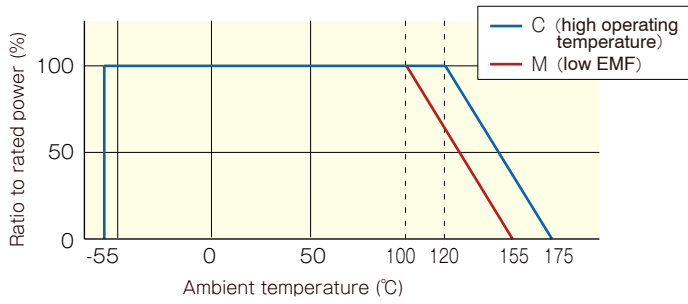



Metal foil low resistance chip resistors (short-side terminal)

■ KRL series

AEC-Q200 Compliant

Features

- High current sensing short side terminal low resistance chip resistor
- Two types available: high temperature (operating temperature up to 175°C), low emf type (operating temperature up to 155°C).
- High current handling capability and wide range of power ratings
- Size: 0510 ~ 50110, power ratings: 0.2W ~ 5W, resistance value range: 5m ~ 1000mΩ
- Face down construction. Choice between bottom only or wrap around terminal



Applications

- Automotive electronics
- Power source devices, ACDC converters, DCDC converters
- Motors, inverters, office automation equipment

◆ Part numbering system

KRL 1220E - C - R010 - F - T1

Series code

Size: KRL0510, KRL0816, KRL1220, KRL1632
KRL2550, KRL3264, KRL50110

Terminal type: D (bottom terminal), E (wrap around terminal)

Packaging quantity:
T1 (1,000pcs), T5 (5,000pcs)

Resistance tolerance

Nominal resistance value

Temperature characteristics type:
C (high operating temperature), M (low EMF)

◆ Electrical Specification

Type	Power ratings	Temperature coefficient of resistance (ppm/°C)	Resistance range(Ω) Resistance tolerance		Resistance value series	Operating temperature		Packaging quantity		
			±1% (F)	±2% (G)		C	M			
KRL0510	0.2W	±50	50m ≤ R ≤ 100m		E-6 / E-12 ^{*2}	-55°C ~ 175°C	-55°C ~ 155°C	10,000pcs		
		±100								
KRL0816	0.3W	±50	10m ≤ R ≤ 500m	—						T1 T5
		±100	—	5m ≤ R ≤ 9m (1m step)						
KRL1220	0.5W	±50	10m ≤ R ≤ 500m	—						
		±100	—	5m ≤ R ≤ 9m (1m step)						
KRL1632	0.75W	±50	10m ≤ R ≤ 500m	—						
		±100	—	5m ≤ R ≤ 9m (1m step)						
KRL2550	1.5W	±50	10m ≤ R ≤ 500m	—						
		±100	—	5m ≤ R ≤ 9m (1m step)						
KRL3264	3W	±50	10m ≤ R ≤ 1000m	—						
		±100	—	5m ≤ R ≤ 9m (1m step)						
KRL50110	5W	±50	10m ≤ R ≤ 1000m	—			T1			
		±100	—	5m ≤ R ≤ 9m (1m step)						

*1 We can meet your requirement for resistance value not specified in above table. Please contact our sales office.

*2 We can meet your requirement outside of E-6/E-12 series resistance. Please contact our sales office.

Current sensing surface mount resistors

KRL series

◆ Dimensions

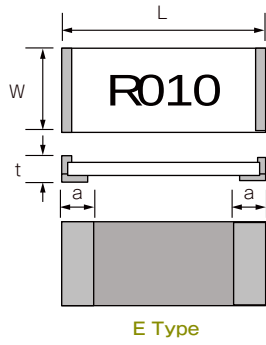
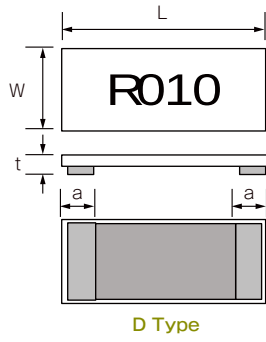

Type	Size (inch)	L	W	t	a
KRL0510	0402	1.00±0.20	0.50±0.20	0.40±0.20	0.30±0.20
KRL0816	0603	1.60±0.20	0.80±0.20	0.50±0.20	0.30±0.15(48mΩ~)/0.55±0.15(20~39mΩ) 0.70±0.15(10~18mΩ)
KRL1220	0805	2.00±0.20	1.25±0.20	0.50±0.20	0.40±0.20
KRL1632	1206	3.20±0.20	1.60±0.20	0.50±0.20	0.50±0.20(9mΩ~)/1.10±0.20(5~8mΩ)
KRL2550	2010	5.00±0.20	2.50±0.20	0.50±0.20	0.60±0.20(9mΩ~)/1.40±0.20(5~8mΩ)
KRL3264	2512	6.30±0.20	3.10±0.20	0.50±0.20	1.00±0.20(9mΩ~)/1.90±0.20(5~8mΩ)
KRL50110	4320	11.00±0.20	5.00±0.20	0.65±0.20	2.36±0.30(8mΩ~)/3.60±0.30(5~7mΩ)

(unit : mm)

◆ Derating Curve

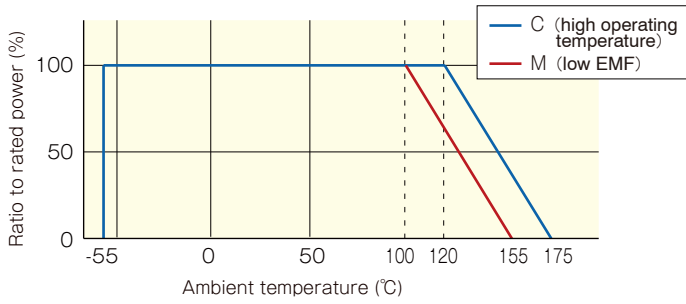

KRL1632E-3A series (1W) is also in our line-up.

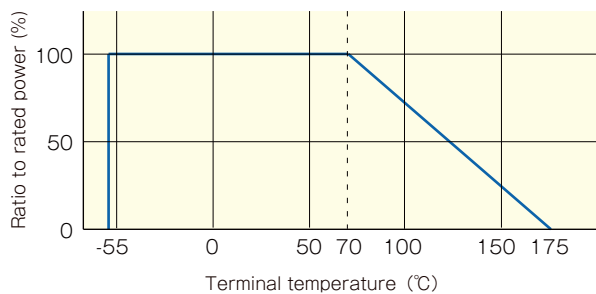



Metal foil low resistance chip resistors (4 terminal type)

■ KRL series

AEC-Q200 Compliant

Features

- Separated voltage terminal for precise measurement of voltage
- TCR stable at very low resistance: 4mΩ: ±50ppm/°C
- Power ratings: 1W ~ 5W

Applications

- Smartphones, mobile telephones, PCs, HDD, audio visual equipment, power devices, inverters.
- automotive electronics, industrial measurement instrumentation/equipment.



◆ Part numbering system

KRL 3216T4 - M - R010 - F - T1
(KRL 3216T4A - M - R010 - F - T1)

Series code

Size: KRL3216T4, KRL6432T4, KRL7638T4
 KRL9045T4, KRL11050T4,

Temperature characteristics type: M (low EMF)

Packaging quantity:
 T1(1,000pcs), T5(5,000pcs)

Resistance tolerance

Nominal resistance value

Current sensing surface mount resistors

KRL series

◆ Electrical Specification

Type	Power ratings	Temperature coefficient of resistance (ppm/°C)	Resistance range(Ω) Resistance tolerance ^{*1}			Resistance value series	Operating temperature	Packaging quantity						
			±1% (F)	±2% (G)	±5% (J)									
KRL3216T4 (KRL3216T4A)	1W	±50 (±35)	4m≤R≤9m (1m step) 10m≤R≤100m R=200m, 500m	—	—	E6 ^{*2}	-55°C ~ 155°C (Code M)	T1 T5						
		±100 (±75)	R=3m	R=2m	R=1m									
KRL6432T4	2W	±50	4m≤R≤9m (1m step) 10m≤R≤100m R=200m, 500m	—	—				E6 ^{*2}	-55°C ~ 155°C (Code M)	T1 T5			
		±100	R=3m	R=2m	R=1m									
KRL7638T4	3W	±50	4m≤R≤9m (1m step) 10m≤R≤100m R=200m, 500m	—	—							E6 ^{*2}	-55°C ~ 155°C (Code M)	T1 T5
		±100	R=3m	R=2m	R=1m									
KRL9045T4	4W	±50	4m≤R≤9m (1m step) 10m≤R≤100m R=200m, 500m	—	—	E6 ^{*2}	-55°C ~ 155°C (Code M)	T1 T5						
		±100	R=3m	R=2m	R=1m									
KRL11050T4	5W	±50	4m≤R≤9m (1m step) 10m≤R≤100m R=200m, 500m	—	—				E6 ^{*2}	-55°C ~ 155°C (Code M)	T1 T5			
		±100	R=3m	R=2m	R=1m									

*1 We can meet your requirement of less than 1mΩ. Please contact our sales office.

*2 We can meet your requirement of resistance value outside of E-6 series. Please contact our sales office.

◆ Dimensions

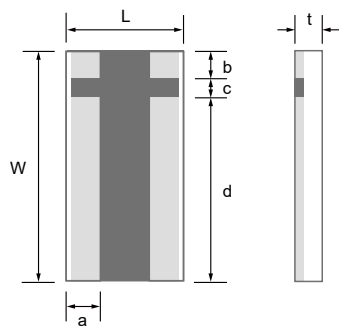

Type	Size (inch)	L	W	a	b	c	d	t
KRL3216T4	1206	1.60±0.20	3.20±0.20	0.35±0.20	0.35±0.15	0.20±0.10	2.65±0.15	0.50±0.20
KRL3216T4A	1206	1.60±0.20	3.20±0.20	0.45±0.20	0.50±0.20	0.50±0.20	2.20±0.20	0.50±0.20
KRL6432T4	2512	3.20±0.20	6.40±0.20	0.50±0.20	0.70±0.15	0.50±0.10	5.20±0.15	0.50±0.20
KRL7638T4	3015	3.80±0.20	7.60±0.20	0.55±0.20	0.80±0.20	0.60±0.20	6.20±0.10	0.50±0.20
KRL9045T4	3518	4.50±0.20	9.00±0.20	0.50±0.20	0.70±0.20	0.50±0.20	5.20±0.10	0.50±0.20
KRL11050T4	4320	5.00±0.20	11.0±0.20	0.70±0.20	1.40±0.20	1.10±0.20	8.50±0.10	0.50±0.20

(unit : mm)

◆ Circuit diagram

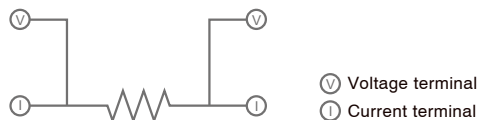

◆ Derating Curve

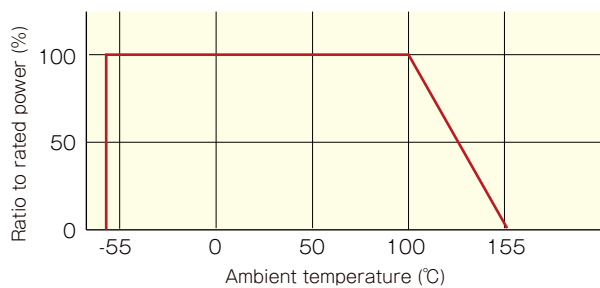

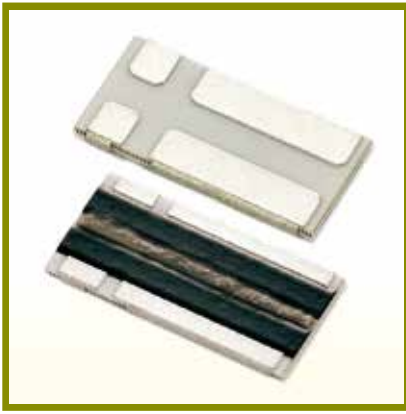

Precision low resistance chip resistors

SHR series

Features

- Precision with separated voltage terminal (4 terminals)
- Resistance tolerance: $\pm 0.5\%$
- Resistance error with self heating: $\pm 100\text{ppm}$ (0.1w ~ 0.5w)

Applications

- Electronic scales, test equipment, measuring equipment



◆ Part numbering system

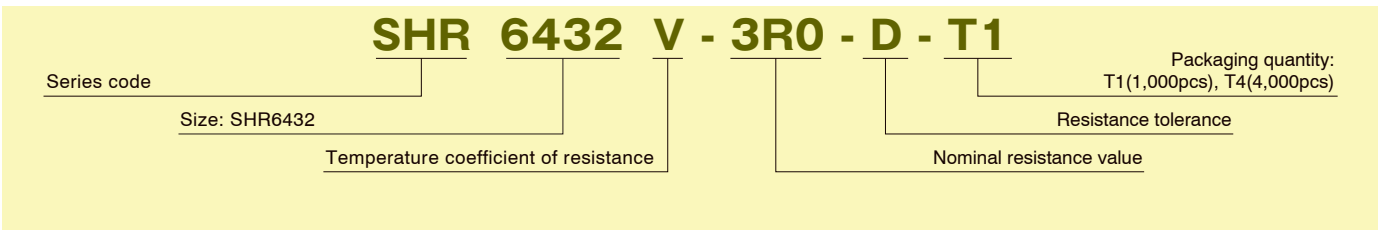

◆ Electrical Specification

Type	Power ratings	Temperature coefficient of resistance ^{*1}	Resistance range(Ω) ^{*2 *3}	Resistance tolerance ^{*2}	Operating temperature	Packaging quantity
		(ppm/ $^{\circ}\text{C}$)	$\pm 0.5\%$ (D)			
SHR6432	0.5W	± 5 (V)	$3 \leq R \leq 8$		$0^{\circ}\text{C} \sim 60^{\circ}\text{C}$	T1 T4

Information on above specification

*1	Coefficient of resistance by self heating	Resistance value, once powered, is influenced by the self-heating obtained by the following formula. *1 above is a designed value $\{R(P2) - R(P1)\} / R(P1) * 100000 \leq \pm 100\text{ppm}$ R(P1) : measured resistance value at 0.1w(25 $^{\circ}\text{C}$) R(P2) : measured resistance value at 0.5w(25 $^{\circ}\text{C}$)
*2	Resistance value range	Resistance value is obtained by the following formula. $R = V / I$ $I = V_s / R_s$ Vs : Voltage applied to the standard resistor Rs : Standard resistance value V:1V (voltage at the time of resistance measurement)
*3	User resistance value	Please contact us for the resistance value you require.

◆ Dimensions

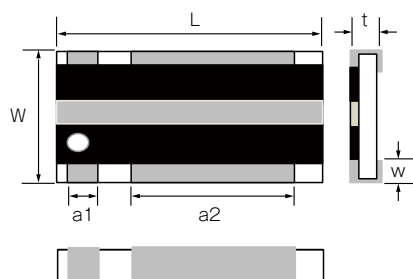

Type	Size (inch)	L	W	t	a1	a2	w
SHR6432V	2512	6.4+0.2/-0.4	3.2±0.2	0.5±0.1	1.0+0.2/-0.1	4.2±0.2	0.55±0.2

(unit : mm)

◆ Temperature characteristics

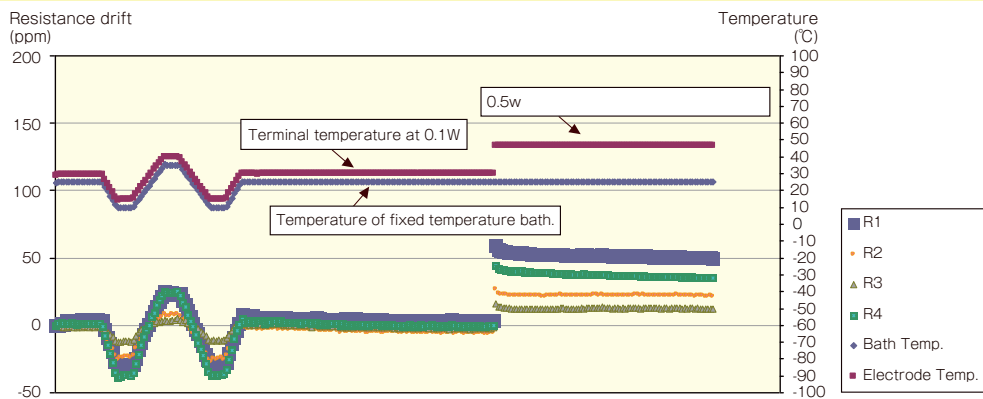



Low resistance chip resistors (long-side terminal)

■ PRL / RL series

Features

- Innovative structure that takes consideration of heat dissipation suppresses the surface temperature enabling the small sizes, reduction of the influence on surrounding components, excellent temperature cycle resistance, low ESL and low noise.

Applications

- PC power sources, inverters, automotive electronics, adapters, industrial machines



◆ Part numbering system

PRL 1220 - R010 - D - T5 Packaging quantity: T5(5,000pcs)

RL 3720W T - R10 - F

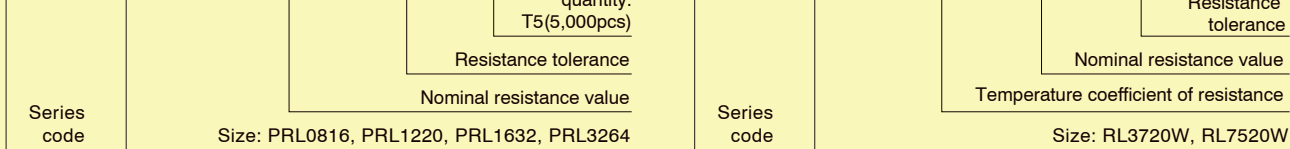

Current sensing surface mount resistors

PRL / RL series

◆ Electrical Specification

Type	Power ratings	Temperature coefficient of resistance (ppm/°C)	Resistance range(Ω) Resistance tolerance				Maximum voltage	Resistance value series	Operating temperature	Packaging quantity
			±0.5% (D)	±1% (F)	±2% (G)	±5% (J)				
PRL0816	1/3W	±50	75m≤R≤100m		-	-	E-24	-40°C ~ 125°C	T5	
		±100	43m≤R≤68m							
		0 ~ +200	33m≤R≤39m							
		0 ~ +350	18m≤R≤27m							
PRL1220	2/3W	±50	56m≤R≤100m		-	-	E-24 1m step (7m ~ 10m)	-40°C ~ 125°C	T5	
		±100	47m≤R≤51m							
		0 ~ +200	20m≤R≤43m							
		0 ~ +350	10m≤R≤18m							
PRL1632	1W	±50	56m≤R≤100m		-	-	E-24 1m step (5m ~ 10m)	-40°C ~ 125°C	T5	
		±100	20m≤R≤51m							
		0 ~ +200	10m≤R≤18m							
		0 ~ +350	5m≤R≤9m							
PRL3264	2W	±50	56m≤R≤100m		-	-	E-24 1m step (3m ~ 10m)	-40°C ~ 125°C	T5	
		±100	47m≤R≤51m							
		0 ~ +200	20m≤R≤43m							
		0 ~ +350	10m≤R≤18m							
RL3720W	1W	±50(Q)	100m≤R≤1		-	-	E-24 1m step (1m ~ 10m)	-55°C ~ 125°C	4,000pcs	
		±100(R)	5m≤R≤91m							
		0 ~ +200(S)	1m≤R≤4m							
		0 ~ +350(T)	1m≤R≤4m							
RL7520W	2W	±50(Q)	100m≤R≤470m		-	-	E-24 1m step (1m ~ 10m)	-55°C ~ 125°C	4,000pcs	
		±100(R)	10m≤R≤91m							
		0 ~ +200(S)	100m≤R≤470m							
		0 ~ +350(T)	10m≤R≤91m							
		0 ~ +420(T)	5m≤R≤9m							
		0 ~ +800(T)	1m≤R≤4m							

◆ Dimensions

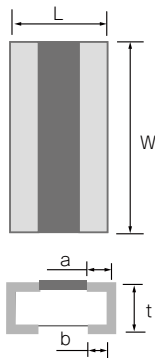

Type	Size (inch)	L	W	a	b	t
PRL0816	0603	0.80±0.20	1.60±0.20	—	0.20±0.10	0.40±0.10
PRL1220	0805	1.25±0.20	2.00±0.20	—	0.35±0.15	0.50±0.10
PRL1632	1206	1.60±0.20	3.20±0.20	—	0.45±0.15	0.50±0.10
PRL3264	2512	3.20±0.20	6.40±0.20	—	0.90±0.15	0.50±0.10
RL3720W	1508	2.00±0.20	3.75±0.30	0.40±0.20	0.40±0.20	0.50±0.20
RL7520W	3008	2.00±0.20	7.50±0.30	0.40±0.20	0.40±0.20	0.50±0.20

(unit : mm)

◆ESL (Equivalent series inductance)

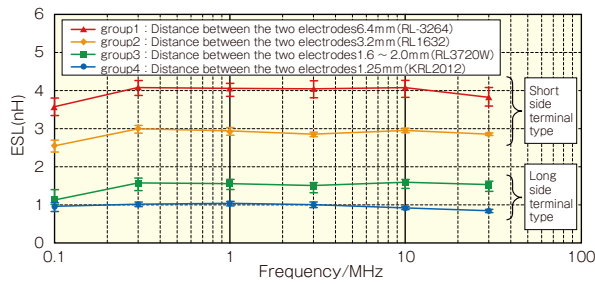

◆Surface temperature data

○ The high power type land pattern and surface temperature

These high-power low resistance chip resistors are designed to dissipate heat efficiently through the land patterns on circuit boards. The actual temperature of the surface of the resistor is dependent upon the dimensions and the shape of the land patterns.

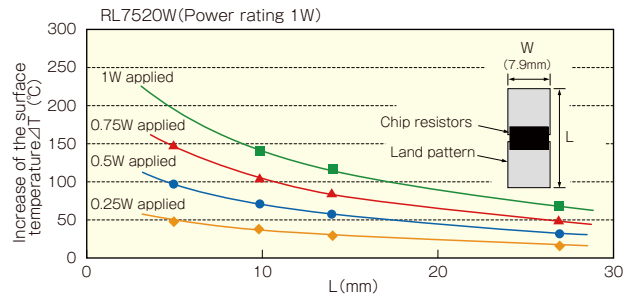
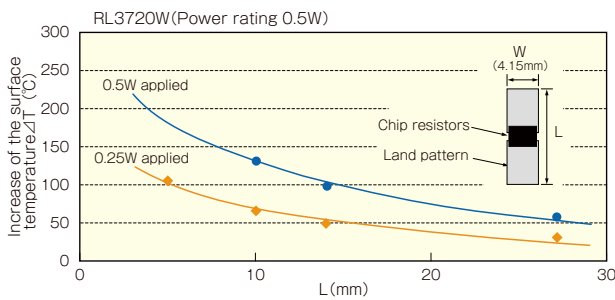
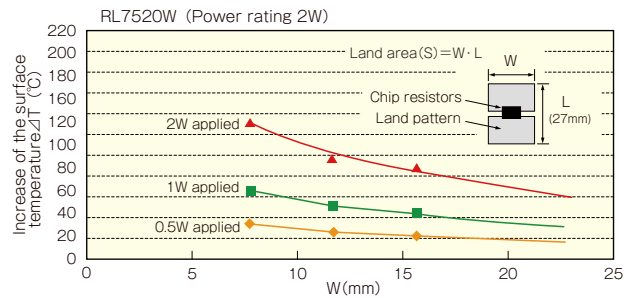
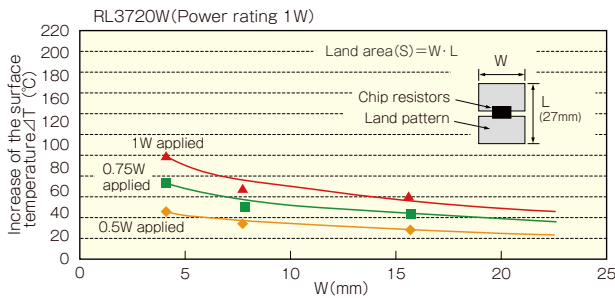

◆Derating Curve

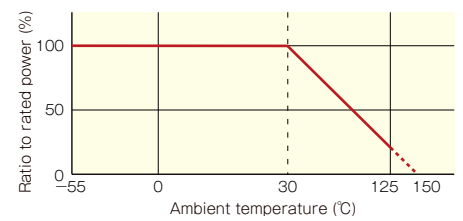
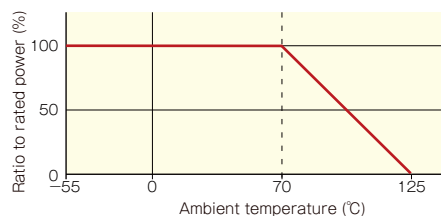
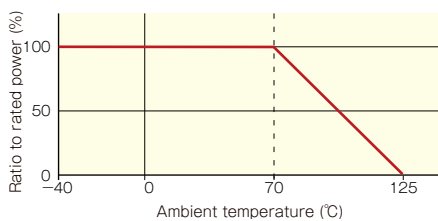

◆Resistance to power pulse

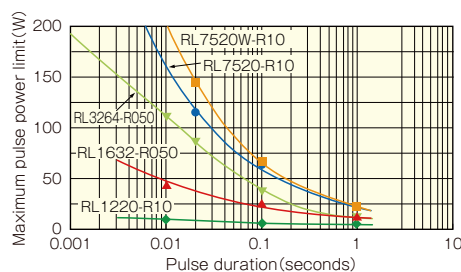

Test procedure

Voltage pulse is applied to the test samples mounted on the test board.
 After each pulse, resistance drift is measured. Pulse voltage is increased until the drift exceeds +/-0.5%.
 The power at that voltage is defined as the maximum pulse power.



Low resistance chip resistors (short-side terminal)

RL series

Features

- Innovative structure that takes consideration of heat dissipation suppress the surface temperature enabling the small sizes reducing the influence of heat on surrounding components.

Applications

- PC power sources, inverters, automotive electronics, adapters, industrial machines



*1 : Except for RL0510, RL1632 and RL3264

◆Part numbering system

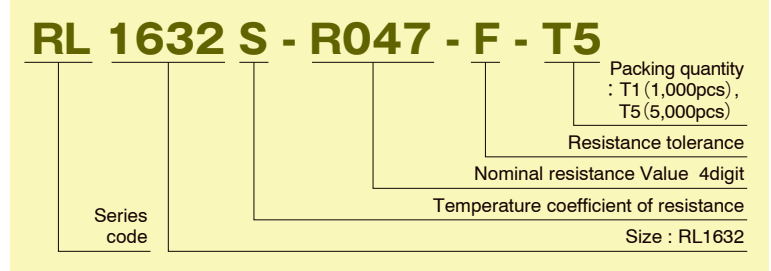
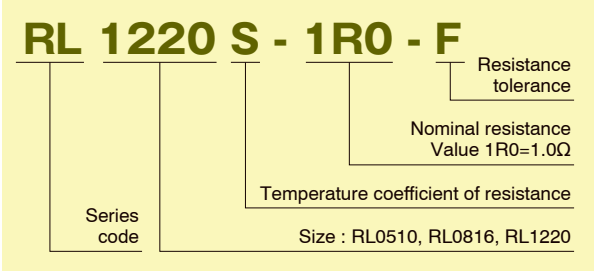

◆Electrical Specification

Type	Power ratings	Temperature coefficient of resistance (ppm/°C)	Resistance range(Ω) Resistance tolerance			Maximum voltage	Resistance value series	Operating temperature	Packaging quantity
			±1% (F)	±2% (G)	±5% (J)				
RL0510	1/8W	0 ~ +350(T)	50m≤R<100m			√(P · R)	E-24	-55°C - 125°C	10,000pcs
	1/6W	0 ~ +200(S)	100m≤R≤4.7						
RL0816	1/4W	0 ~ +200(S)	20m≤R<100m						
		0 ~ +350(T)	20m≤R<100m						
	1/5W	0 ~ +100(R)	100m≤R≤6.8	—					
		0 ~ +200(S)	7.5≤R≤68						
RL1220	1/4W	0 ~ +200(S)	43m≤91m						
		0 ~ +350(T)	10m≤91m						
	1/3W	0 ~ +100(R)	100m≤R≤10						
		0 ~ +200(S)	11≤R≤100						
RL1632	1/2W	0 ~ +100(R)	510m≤R≤4.7 ^{*1}	56m≤R≤470m	—	—	—	T1 T5	
		0 ~ +200(S)	—	33m≤R≤51m	—				
		0 ~ +350(T)	—	27m≤R≤30m	18m≤R≤24m				
		0 ~ +500(T)	—	—	10m≤R≤16m				

*1 RL series with resistance tolerance 0.5% is also available. Please contact our sales office.

Current sensing surface mount resistors
RL series

◆ Dimensions

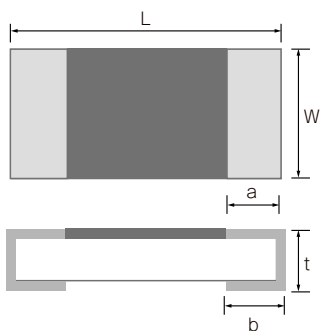

Type	Size (inch)	L	W	a	b	t
RL0510	0402	1.00±0.05	0.50±0.05	0.15±0.10	0.25±0.10	0.35+0.15/-0.10
						0.15±0.10
RL0816	0603	1.60±0.20	0.80±0.20	0.20±0.15	0.25±0.20	0.45+0.15/-0.10
						0.20±0.15
RL1220	0805	2.00±0.20	1.25±0.20	0.40±0.20	0.40±0.20	0.50±0.20
						0.40±0.10
RL1632	1206	3.20±0.20	1.60±0.20	—	1.00±0.15	0.50±0.15

(unit : mm)

◆ Derating Curve

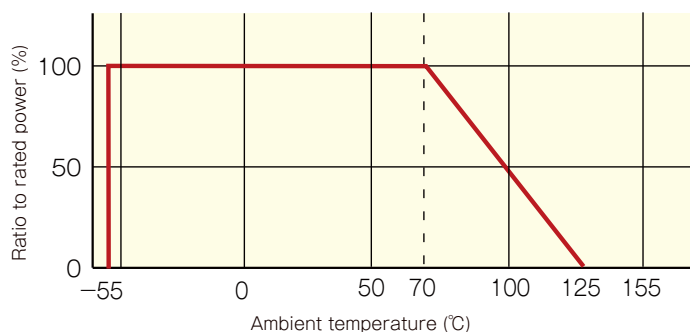

◆ Resistance to power pulse

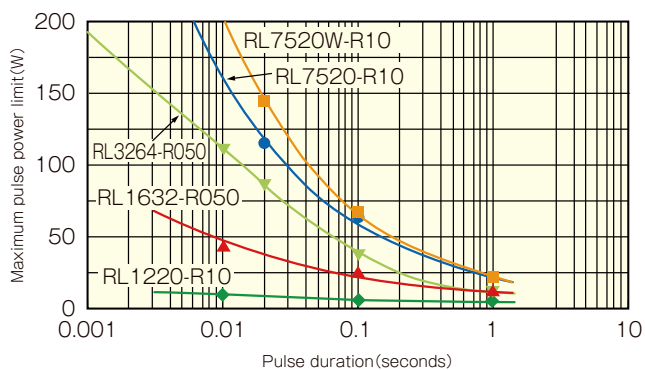

Test procedure

Voltage pulse is applied to the test samples mounted on the test board.
 After each pulse, resistance drift is measured. Pulse voltage is increased until the drift exceeds +/-0.5%.
 The power at that voltage is defined as the maximum pulse power.



High Current chip jumpers

YJP series

Features

- Simplify power line change, looping and circuit design when changing current
- Less than 0.3mΩ within operating temperature range
- Surface mount type eliminating jumper leads
- Help reduce the voltage drop/current loss in high current circuit
- Highly stable within operating temperature (-40~125°C)
- Halogen free

Applications

- Mobile phones, smart phones, automotive electronics, power sources, servers, PCs, etc.



Part numbering system

YJP 1608 - R001

Series code

Size : YJP1608, YJP3216

Maximum resistor value

Electrical Specification

Type	Resistance range (Ω)	Rated maximum current	Operating temperature	Rated ambient temperature	Packaging quantity
YJP1608	0.2±0.1 mΩ Maximum resistance is less than 0.3mΩ under the operating temperature range	10A	-40 ~+125°C	+70°C	5,000pcs
YJP3216	0.2±0.1 mΩ Maximum resistance is less than 0.3mΩ under the operating temperature range	20A	-40 ~+125°C	+70°C	5,000pcs

Dimensions

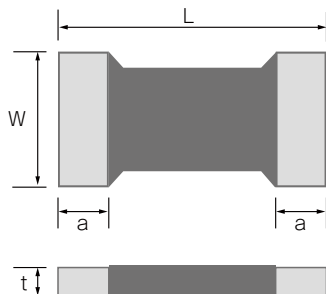

Type	Size (inch)	L	W	a	t
YJP1608	0603	1.60±0.20	0.80±0.20	0.30±0.10	0.30±0.10
YJP3216	1206	3.20±0.20	1.60±0.20	0.30±0.10	0.30±0.10

(unit : mm)

Power choke coils

Power choke coils

PCMB series

Small power choke coils

PCMB series, PS series



Power choke coils

■PCMB series

Features

- Low profile (3.0 mm max) and small size (7.3mm x 6.6mm)
- Small size allowing space saving on the board
- Low loss and high saturating current.

Applications

- PCs, servers, power sources, mobile devices, flat screen TVs etc.



◆Part numbering system

PCMB	13**	-	***	M	N(S,T)	Material : refer to the table for electrical characteristics
Series code						
Size : (063T=6.6×7.3×3.0mm, 104T=10×11.5×4.0mm, 133E=12.6×13.8×3.5mm, 135T=12.6×13.8×5.0mm)				Inductance tolerance : M=±20%		
				Inductance value (R56=0.56μH, R68=0.68μH)		

Rated current : the current that increases the temperature by 40°C

Saturating current : The current that reduces inductance by 30% (PCMB/PS/PST/PL).

*Contact us for details.

◆Dimensions, Electrical characteristics

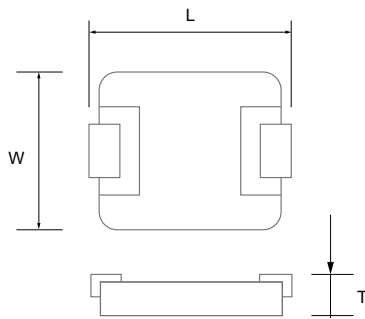

◆Equivalent circuits

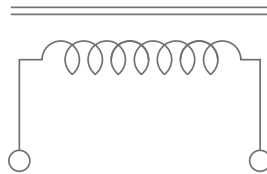

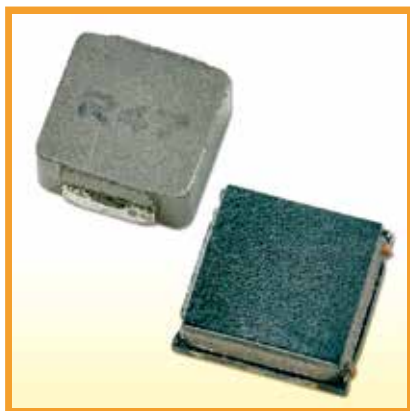

Small power choke coils

■ PCMB series, PS series

Features

- Low DCR and large current for small sizes
- High efficiency and low loss

Applications

- PCs, servers, power sources, mobile devices, flat screen TVs etc.



◆ Part numbering system

PS 031* - * M (S)**

Series code	PS 031*	-	***	M	(S)	
Size : B(2.9mm×2.9mm×1.2mm), T(2.9mm×2.9mm×1.0mm)				Material : refer to the table for electrical characteristics		
				Resistance tolerance : M=±20%		
				Inductance value		

Rated current : the current that increases the temperature by 40°C
 Saturating current : The current that reduces inductance by 20% (PCMC) or 30% (PCMB/PS/PST/PL)
 *Contact us for details.

◆ Dimensions, Electrical characteristics

PCMB type

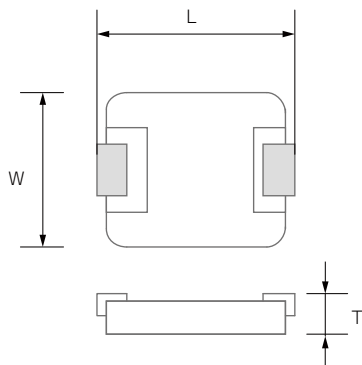

PS*, PS type

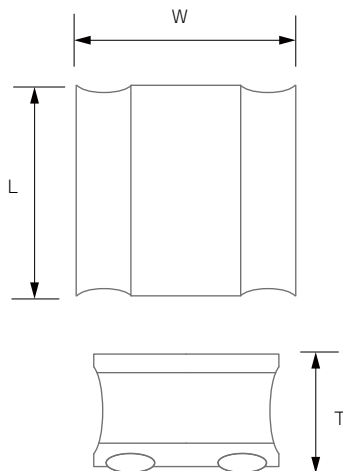

Power choke coils

PCMB series, PS series

High frequency surface mount components

High Frequency Chip Attenuator

ATS series

High Precision Chip Attenuator

PAT series

High Precision Chip Attenuator

(W type)

PAT series, W type

Thermo-variable chip attenuators

P * V series

Power Splitter

PS series

High power thin film chip terminator

PCS series, HPT series



High Frequency Chip Attenuator

■ATS series

Features

- Attenuation range up to 30GHz
- Internal circuit specially designed for 0-10dB attenuation.
- Miniature surface mount chip attenuator (2012 size)
- Signal line sandwiched by ground – excellent heat dissipation and low noise.

Applications

- Wireless communication devices and base stations
- Wireless communication modules



◆Part numbering system

ATS 2012 - 10dB - T1

Series code

Packing quantity :
T1 (1,000pcs) , T05 (500pcs)

Size : ATS2012

Attenuation

◆Electrical Specification

Type	ATS2012			
Attenuation	0dB	1~2dB(1dB step)	3~7dB(1dB step)	8~10dB(1dB step)
Circuit Type	Thru	Tee	Pi (π)	Dual pi (Dual π)
Equivalent circuits	①	②	③	④
Attenuation tolerance	$\pm 0.5\text{dB}$ (0 ~ 20GHz) , $\pm 0.75\text{dB}$ (20 ~ 30GHz)			
V S W R	≤ 1.5 (0 ~ 20GHz) , ≤ 1.7 (20GHz ~ 30GHz)			
Impedance	50 Ω			
Operating frequency	DC~30GHz			
Rated power	100mW			
Rated operating temperature	70 $^{\circ}\text{C}$			
Operating temperature	-55 $^{\circ}\text{C}$ ~+125 $^{\circ}\text{C}$			
Packaging quantity	500pcs/reel(T05)			
	1,000pcs/reel(T1)			

◆Equivalent Circuit and pin arrangement



1 : Input pin
2 : Output pin
3 : GND

◆ Dimensions

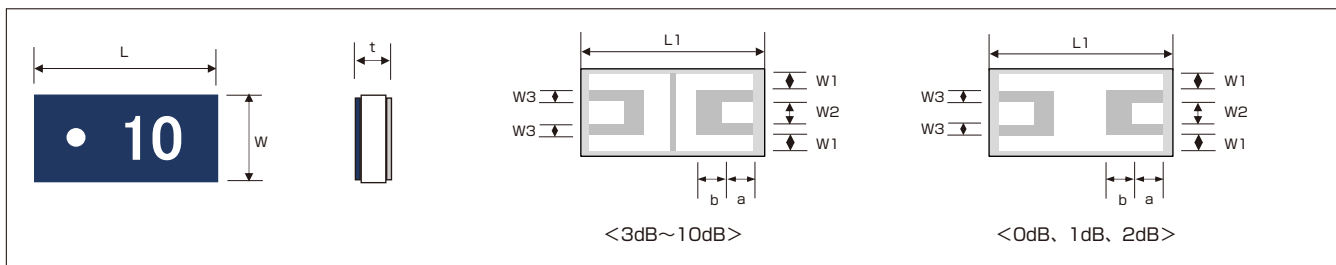

Type	Size (inch)	L	W	t	L1	a	b	W1	W2	W3
ATS2012	0805	2.00±0.20	1.22±0.20	max 0.40	1.80±0.10	0.36±0.10	0.33±0.10	0.25±0.10	0.25±0.10	0.15±0.10

(unit : mm)

◆ Derating Curve

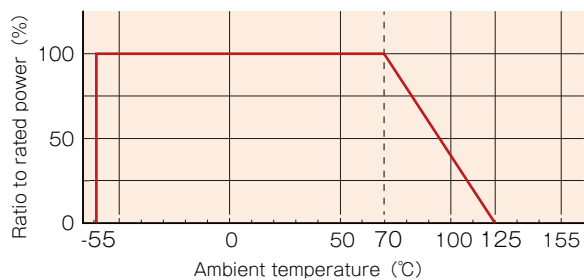



High Precision Chip Attenuator

■ PAT series

Features

- One chip attenuator covers wide frequency range.
- Wrap around terminal similar to regular chip resistors makes it easy to mount.
- Sizes from 1005 to 3042 are offered, which contribute to miniaturization of devices.

Applications

- Cell phone base stations
- Wireless communication modules
- Wide band measurement instrumentation



◆ Part numbering system

PAT 1632 - C - 3dB - T1

Series code

Size : PAT0510S, PAT0816
PAT1220, PAT1632, PAT3042S

Packing quantity:
T=Tape (T10/T1/T2/T5), B=Bulk

Attenuation : 2 digit

Impedance: C=50Ω D=75Ω

◆ Electrical Specification

Type	PAT0510S			PAT0816			PAT1220	PAT1632		PAT3042S	
Attenuation	0 ~ 3dB (1dB step)	4 ~ 7dB (1dB step)	8 ~ 10dB (1dB step)	0 ~ 3dB (1dB step)	4 ~ 7dB (1dB step)	8 ~ 10dB (1dB step)	0 ~ 10dB (1dB step)	0 ~ 10dB (1dB step)	16dB	0 ~ 10dB (1dB step)	16,20dB
Attenuation tolerance	±0.3dB	±0.5dB	±0.7dB	±0.3dB	±0.5dB	±0.7dB	±0.3dB	±0.3dB	±0.5dB	±0.3dB	±0.5dB
Impedance	50Ω(C)			50Ω(C)				50Ω(C)		50Ω(C), 75Ω(D)	
VSWR	<1.3			<1.3(~6GHz), <1.5(6~10GHz)			<1.3	<1.3		<1.2(50Ω), <1.3(75Ω)	
Operating frequency	DC ~ 10GHz			DC ~ 10GHz				DC ~ 3GHz		50Ω: DC ~ 3GHz 75Ω: DC ~ 2GHz	
Rated power	32mW			64mW			100mW	125mW		250mW	
Rated operating temperature	70°C										
Operating temperature	-55°C~+125°C										
Packaging quantity	10,000pcs/reel (T10)							100pcs/Bag (B) 1,000pcs/reel (T1) 5,000pcs/reel (T5)		50pcs/Bag (B) 1,000pcs/reel (T1) 2,000pcs/reel (T2)	

◆ Equivalent Circuit and pin arrangement

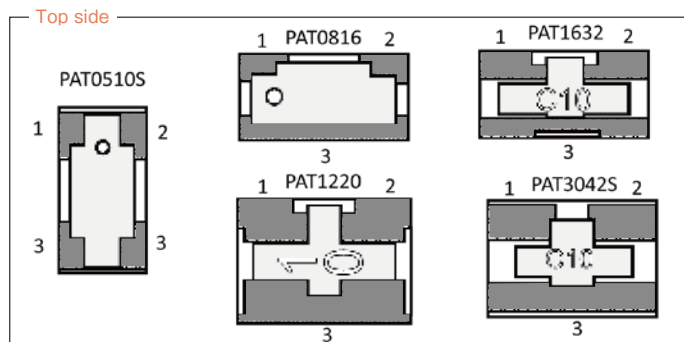
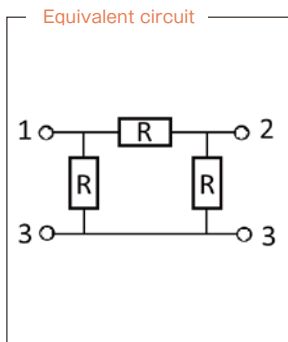

◆ Dimensions

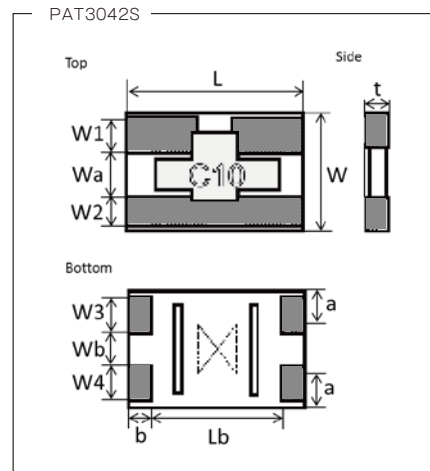
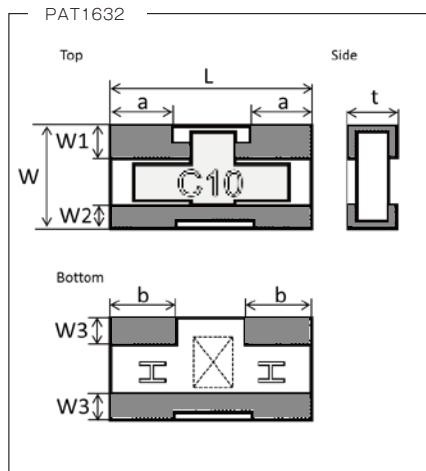
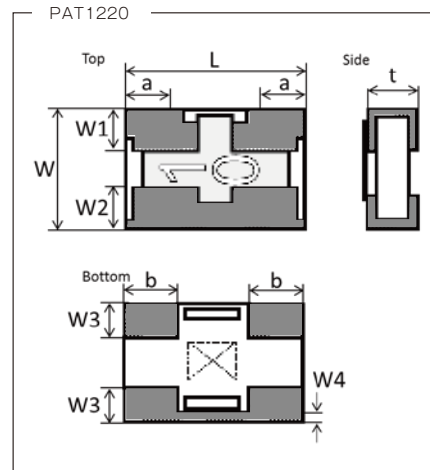
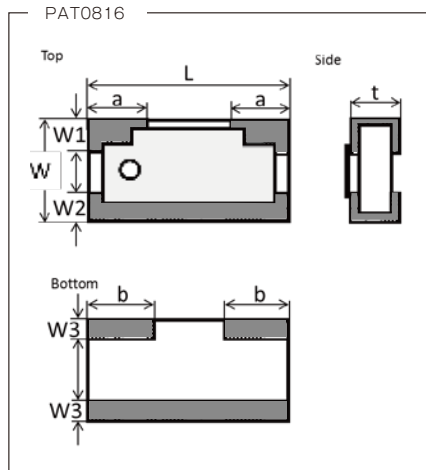
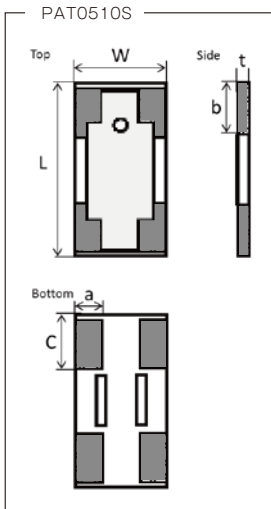

Type	Size (inch)	L	W	t	a	c	b
PAT0510S	0402	1.00±0.05	0.50±0.05	0.34±0.05	0.12±0.04	0.27±0.05	0.25±0.05

(unit : mm)

Type	Size (inch)	L	W	t	a	b	W1	W2	W3	W4
PAT0816	0603	1.60±0.10	0.80±0.10	0.40±0.10	0.50±0.15	0.50±0.10	0.25±0.10	0.15±0.10	0.20±0.10	—
PAT1220	0805	2.00±0.10	1.25±0.10	0.40±0.10	0.50±0.20	0.60±0.20	0.40±0.20	0.40±0.20	0.35±0.20	< 0.25
PAT1632	1206	3.20±0.20	1.60±0.20	0.40±0.10	1.00±0.25	1.00±0.25	0.55±0.25	0.40±0.25	0.40±0.20	—

(unit : mm)

Type	Size (inch)	L	W	t	a	b	Lb
PAT3042S 50Ω(C)	1612	4.20±0.20	3.00±0.20	0.80±0.15	0.80±0.20	0.50±0.20	3.10±0.20
PAT3042S 75Ω(D)	1612	4.20±0.20	3.00±0.20	0.80±0.15	0.80±0.20	0.30±0.20	3.50±0.20

Type	W1	W2	Wa	W3	W4	Wb
PAT3042S 50Ω(C)	0.95±0.20	0.80±0.20	1.05±0.20	0.95±0.20	0.95±0.20	0.95±0.20
PAT3042S 75Ω(D)	0.55±0.20	0.60±0.20	1.55±0.20	0.55±0.20	0.60±0.20	1.55±0.20

(unit : mm)

High Precision Chip Attenuator

■ PAT series

◆ Recommended land patterns(soldering footprints)

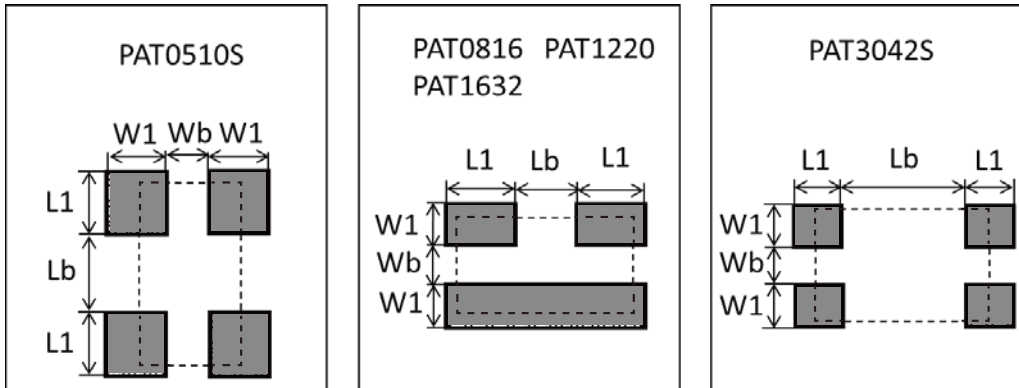

Size	W1	Wb	L1	Lb
PAT0510S	0.30	0.20	0.35	0.37
PAT0816	0.40	0.30	0.60	0.50
PAT1220	0.70	0.50	0.80	0.70
PAT1632	0.80	0.65	1.20	1.00
PAT3042S (50Ω)	1.10	0.90	1.20	2.90
PAT3042S (75Ω)	1.00	1.10	1.00	3.30

(unit : mm)

◆ Benefits of PAT series

Three resistive elements are integrated inside of this chip attenuator. If you use discrete resistors to construct an attenuator, 3 resistors are needed. The merits of one attenuator displacing 3 resistors are:

- 1) Three precision resistors are integrated as an attenuator. Therefore, precision attenuation can be easily achieved with this attenuator.
- 2) Because 3 elements are integrated in a small area, parasitic capacitance and inductance are minimized and desired attenuation can be easily attained.
- 3) One attenuator can replace 3 discrete resistors, which contributes miniaturizing the circuit and makes the circuit more reliable

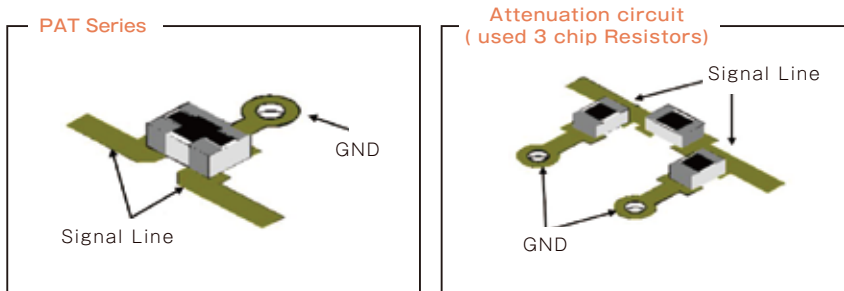

High frequency surface mount components

PAT series

◆ Derating Curve

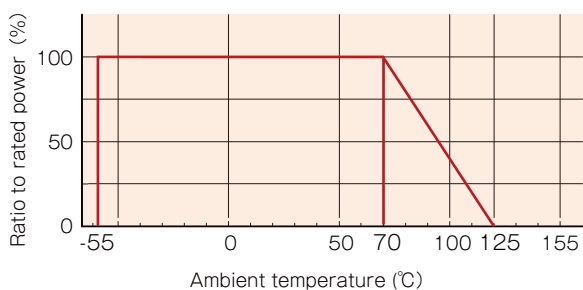

◆ High frequency characteristics

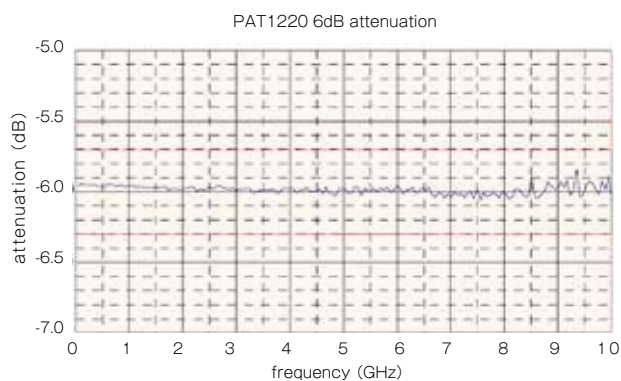
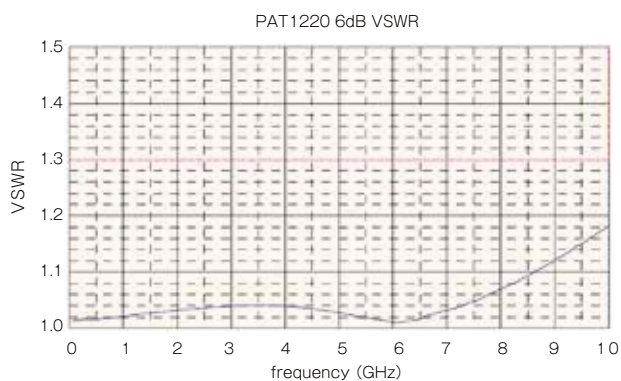
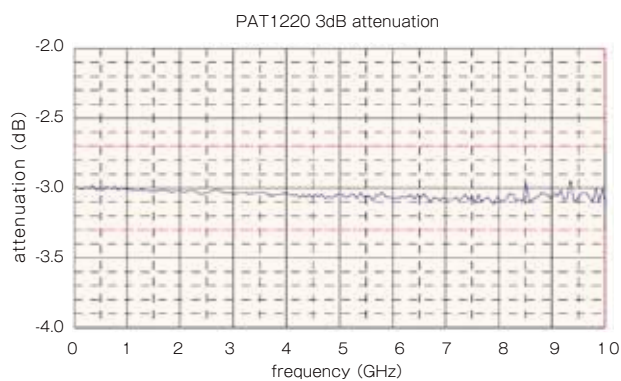
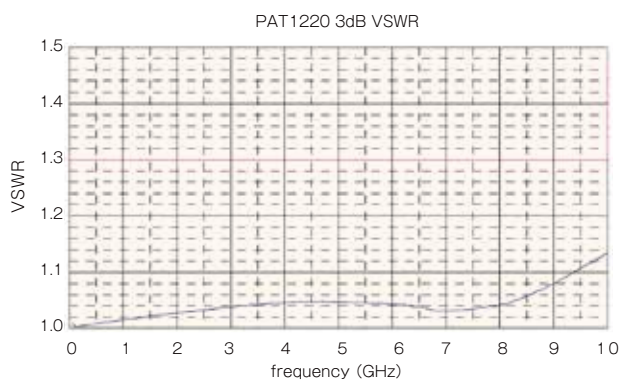
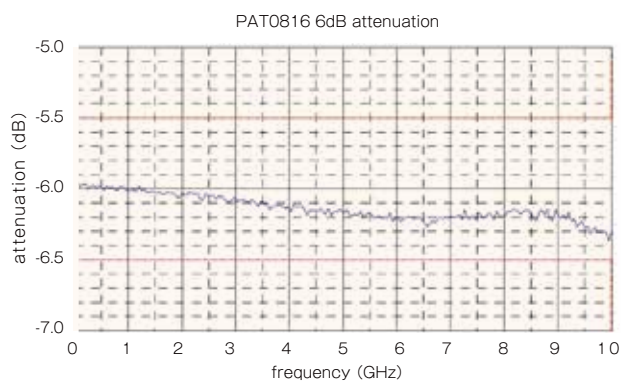
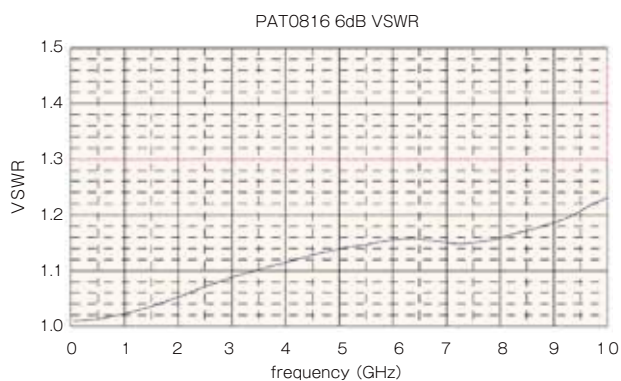
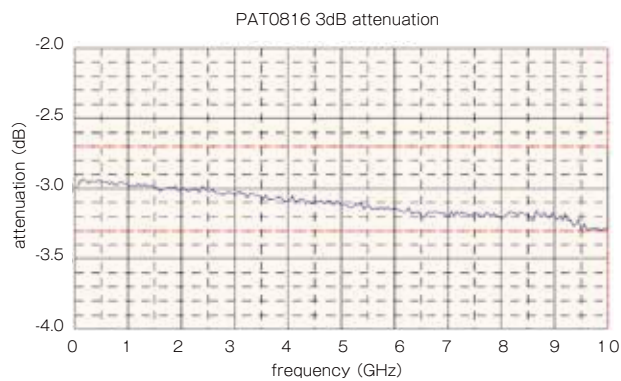
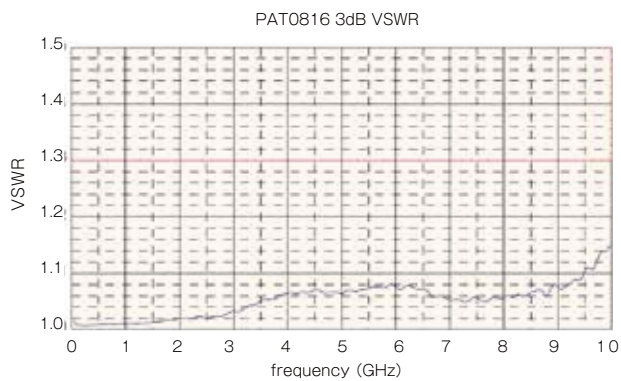

High frequency surface mount components

PAT series



High Precision Chip Attenuator

■ PAT Series W type

Features

- Single attenuating element realizes excellent attenuating characteristics
- Wide frequency range makes it possible to handle circuits with different frequency with ease
- The distribution of the terminals, signal terminals in the middle and ground terminal at ends, are designed for easy integration to coaxial connectors



Applications

- Attenuator for coaxial lines/circuit
- Attenuator for measuring instrumentation

◆ Part numbering system

PAT 3042 - C - 3dB - A - T1

Series code

Size : PAT3042, PAT4556, PAT3060H

Impedance: C=50Ω

Packing quantity:

T=Tape (T1/T2), B=Bulk

Attenuation tolerance (PAT3042/4556)

Attenuation

◆ Electrical Specification

Type	PAT3042	PAT4556	PAT3060H
Attenuation	0-10(1dB step), 16,20dB	0-10(1dB step), 13,16,20dB	1,2,3,5,6,10dB
Attenuation tolerance	Refer table1		±0.5dB
Impedance	50Ω(C)	50Ω(C)	50Ω(C)
VSWR	<1.1(DC-2GHz) <1.2(2-5GHz), <1.3(5-10GHz)		<1.2
Operating frequency	DC ~ 10GHz		DC ~ 6GHz
Rated power	250mW	500mW	5W
Rated operating temperature	70°C		
Operating temperature	-55°C~+125°C		
Packaging quantity	50pcs/bag (B) 1,000pcs/reel (T1) 2,000pcs/reel (T2)	50pcs/bag (B) 1,000pcs/reel (T1)	100pcs/bag (B) 1,000pcs/reel (T1)

Attenuation tolerance				
Attenuation*	Rank	DC~2GHz	2~5GHz	5~10GHz
0~10dB	A	±0.1dB	±0.2dB	±0.4dB
0~10dB	B	±0.2dB	±0.3dB	±0.5dB
16,20dB (13dB)**	B	±0.2dB	±0.3dB	±0.5dB

* : Applicable products: PAT3042 and PAT4556

** : Applicable product is only PAT4556

◆ Equivalent Circuit and pin arrangement

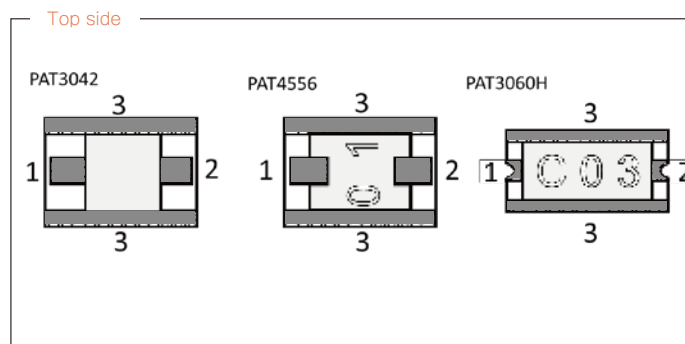
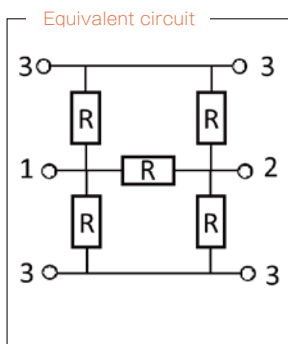

◆ Dimensions

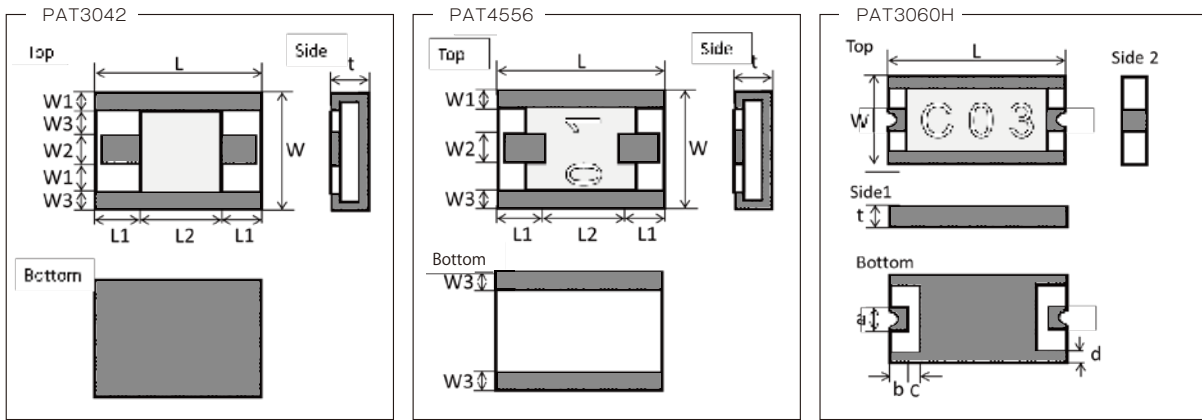

Type	PAT3042					
Size(inch)	1612					
Symbol	0dB	1dB	2,3dB	4,5,6dB	7,8,9,10dB	16,20dB
L	4.2±0.20					
W	3.0±0.20					
t	0.8±0.15					
W1	0.40±0.15	0.30±0.15	0.40±0.15			
W2	0.66±0.10	0.66±0.10	0.90±0.10			
W3	0.77±0.10	0.85±0.10	0.65±0.10			
L1	—	1.90±0.20	1.90±0.20	1.75±0.20	1.60±0.20	1.15±0.20
L2	4.20±0.20	0.30±0.20	0.30±0.20	0.60±0.20	0.90±0.20	1.80±0.20

(unit : mm)

Type	PAT4556	
Size(inch)	2218	
Symbol	0dB	1 ~ 20dB
L	5.60±0.20	
W	4.50±0.20	
t	0.80±0.15	
W1	0.60±0.10	
W2	0.64±0.10	1.3±0.10
W3	0.60±0.10	

(unit : mm)

Type	PAT3060H
Size(inch)	2412
L	6.00±0.20
W	3.00±0.20
t	0.70±0.15
a	0.80±0.15
b	0.45±0.10
c	0.50±0.10
d	max 0.5

(unit : mm)

◆ Recommended land patterns(soldering footprints)

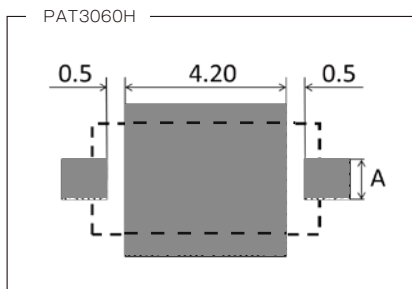

PCB material	Pattern A size
Glass epoxy t=0.6mm	1.07mm
Teflon t=0.6mm	1.52mm

· Refer to the information on the next page on how to use PAT3042/PAT 4556

High Precision Chip Attenuator

■ PAT Series W type

◆ High frequency characteristics (measured value)

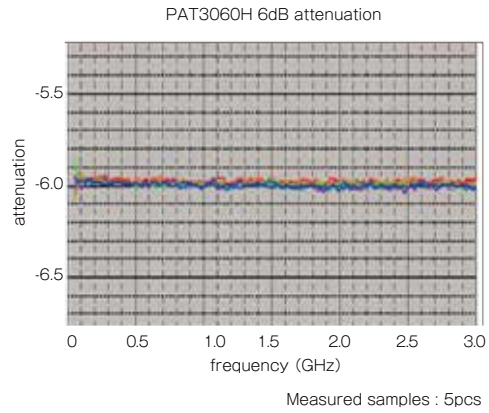
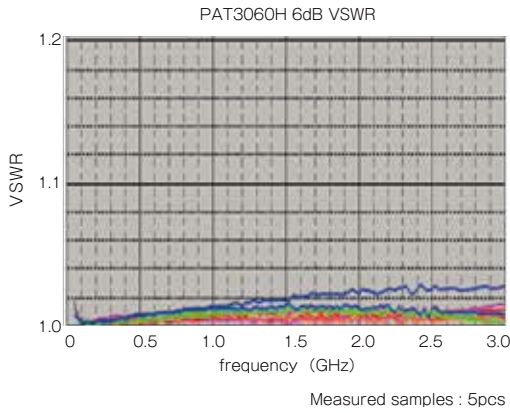

◆ Mounting example

The shape of this attenuator chip is designed to match coaxial connectors' shape so that it can be integrated easily. In this case, the center conductor should be soldered to the signal terminals (the middle terminals) and metallic shield should be soldered to the ground terminals (the end terminals.)

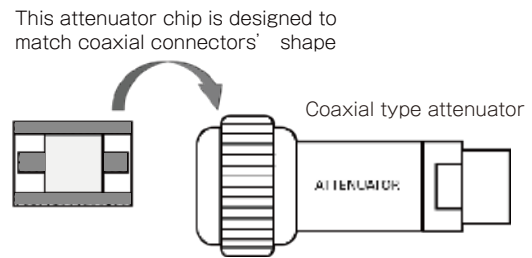

◆ Derating Curve

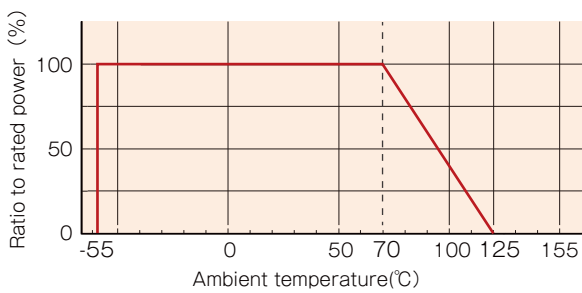

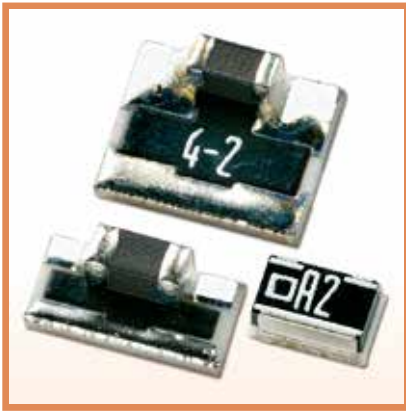

Thermo-variable Chip Attenuator

■ P*V Series

Features

- Simple solution for compensation for the temperature drift of GaAs amplifier
- Resistive construction allows operation in wide frequency range
- Ten different attenuation x 8 or 9 temperature characteristics: over 80 different offerings to meet any amplifier characteristics.

Applications

- Cell phone base station
- Wireless remote controller



*Except for Chinese RoHS

◆ Part numbering system

PXV 1220S - 6dB N1 - T

Series code			Packing quantity: T=Tape (T1), B=Bulk
Size : PXV1220S, PBV1632S PAV3137S			Thermo sensitive characteristic: N1~N9
			Attenuation : 2 digit

◆ Electrical Specification

Type	PXV1220S	PBV1632S	PAV3137S
Attenuation	1 ~ 10dB (1dB Step)	1 ~ 10dB, 16dB (1dB Step)	1 ~ 10dB (1dB Step)
Attenuation tolerance	±0.5dB(@25°C, no load)		
Impedance	50Ω		
VSWR	<1.3		
Termo Sensitive characteristic	N1 ~ N9 (1db ~ 3dB) N1 ~ N8 (4db ~ 10dB)	N1 ~ N9 (1db ~ 3dB) N1 ~ N8 (4db ~ 16dB)	N1 ~ N9 (1db ~ 3dB) N1 ~ N8 (4db ~ 10dB)
Operating frequency	DC ~ 3GHz		DC ~ 6GHz
Rated power	63mW	100mW	2W
Operating temperature	-40°C~+100°C		-40°C~+125°C
Packaging quantity	100pcs/bag(B) 1,000pcs/reel(T1)	20pcs/bag (B) 1,000pcs/reel (T1)	

◆ Equivalent Circuit and pin arrangement

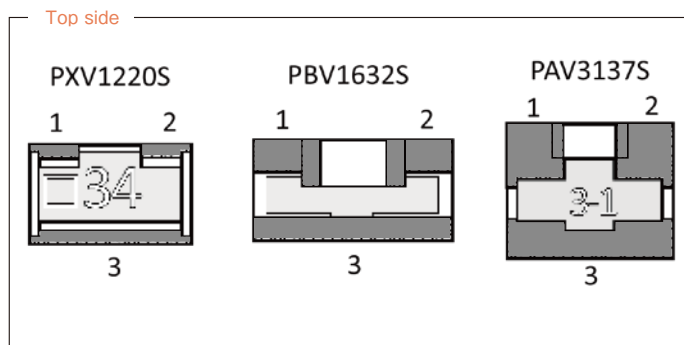
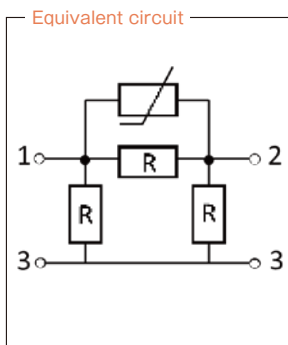

◆ Dimensions

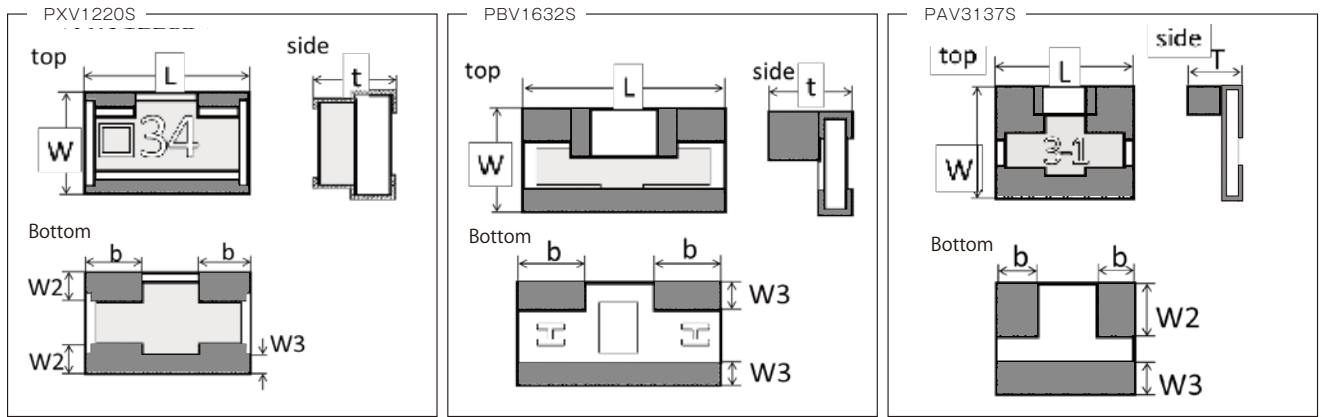

Type	Size (inch)	L	W	t	b	W2	W3
PXV1220S	0805	2.00±0.20	1.25±0.20	1.1max	0.65±0.20	0.38±0.20	0.25±0.35
PBV1632S	1206	3.20±0.20	1.60±0.20	1.5max	1.00±0.20	—	0.40±0.35
PAV3137S	1512	3.70±0.20	3.10±0.20	1.5max	1.00±0.20	1.50±0.20	0.85±0.20

(unit : mm)

◆ Recommended land patterns(soldering footprints)

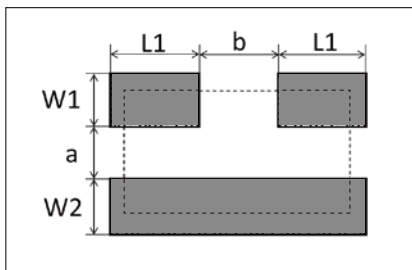

Type	W1	W2	a	L1	b
PXV1220S	0.70	0.70	0.50	0.80	0.70
PBV1632S	0.80	0.80	0.70	1.20	1.00
PAV3137S	1.55	1.15	0.60	1.25	1.50

(unit : mm)

◆ Derating Curve

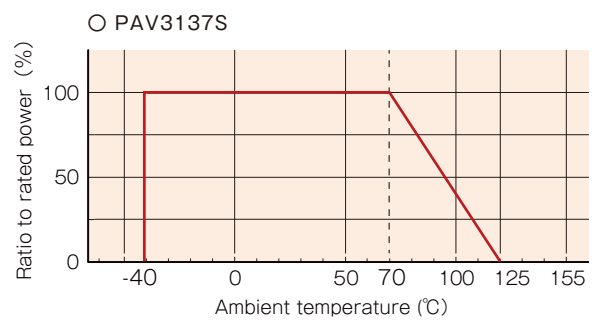
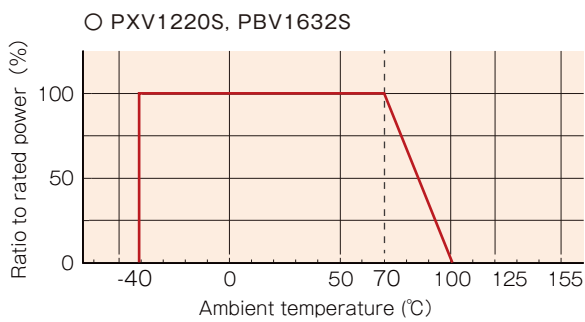

Thermo-variable Chip Attenuator

■ P*V Series

◆ Attenuation amount temperature characteristic

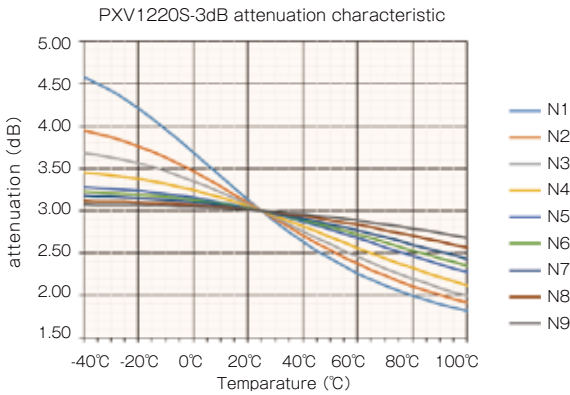

PXV1220S-3dB-N*

Temperature	N1	N2	N3	N4	N5	N6	N7	N8	N9
-40 ~ +25°C	-0.0243	-0.0146	-0.0105	-0.00693	-0.00433	-0.0035	-0.00273	-0.0018	-0.00117
+25 ~ +100°C	-0.0158	-0.0145	-0.0133	-0.0117	-0.00963	-0.00867	-0.00754	-0.00578	-0.00423
-40 ~ +100°C	-0.0197	-0.0145	-0.012	-0.00949	-0.00717	-0.00627	-0.0053	-0.00393	-0.00281
Temp. characteristic tolerance	max ±10%							max ±15%	

(unit : dB/°C)

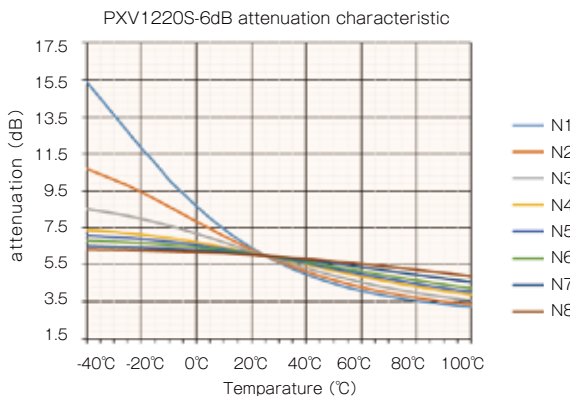

PXV1220S-6dB-N*

Temperature	N1	N2	N3	N4	N5	N6	N7	N8
-40 ~ +25°C	-0.145	-0.0725	-0.0388	-0.0213	-0.0166	-0.0125	-0.00794	-0.00504
+25 ~ +100°C	-0.037	-0.0351	-0.0323	-0.0282	-0.0261	-0.0235	-0.0191	-0.0148
-40 ~ +100°C	-0.0873	-0.0525	-0.0353	-0.025	-0.0217	-0.0184	-0.0139	-0.0102
Temp. characteristic tolerance	max ±10%							max ±15%

(unit : dB/°C)

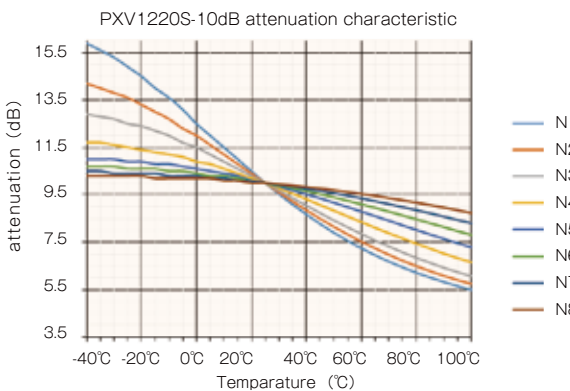

PXV1220S-10dB-N*

Temperature	N1	N2	N3	N4	N5	N6	N7	N8
-40 ~ +25°C	-0.0908	-0.0643	-0.0449	-0.0264	-0.0161	-0.0107	-0.00716	-0.00475
+25 ~ +100°C	-0.0601	-0.0568	-0.0525	-0.0447	-0.0362	-0.0292	-0.0227	-0.0169
-40 ~ +100°C	-0.0743	-0.0603	-0.049	-0.0362	-0.0269	-0.0206	-0.0155	-0.0113
Temp. characteristic tolerance	max ±10%						max ±15%	

(unit : dB/°C)

◆ High frequency characteristics (measured value)

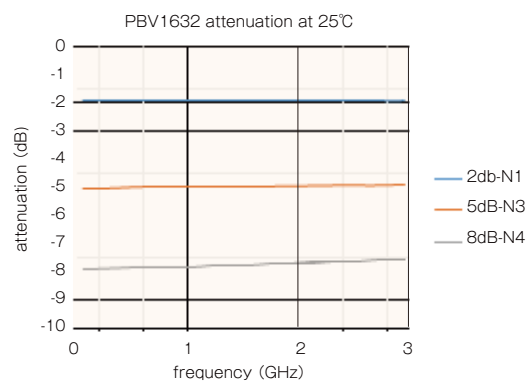
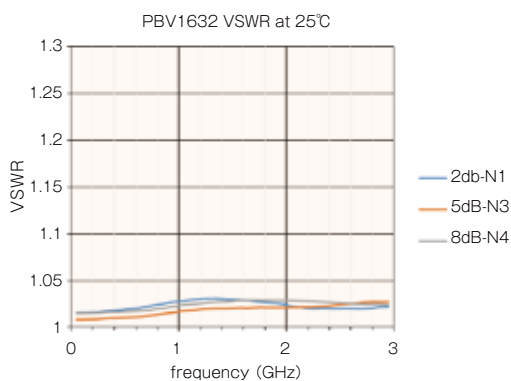
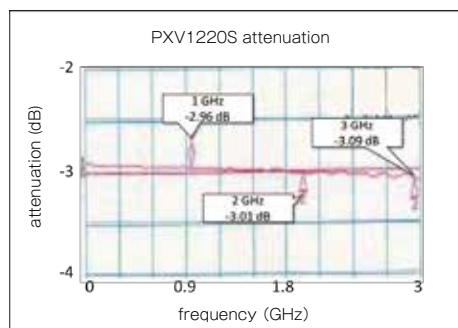
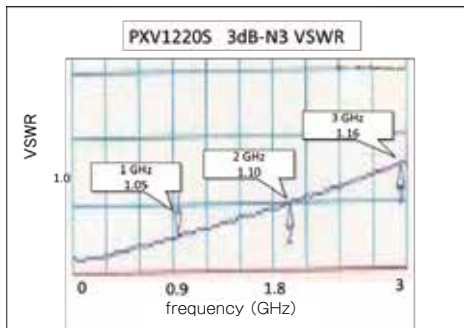

◆ Example of use

- High frequency GaAs transistor amplifiers' gain decreases as temperature increases.
- Integrating this attenuator into amplifier circuit compensates the gain loss and keep the gain constant in the circuit. (figure below)
- Replaces complex feedback circuits.

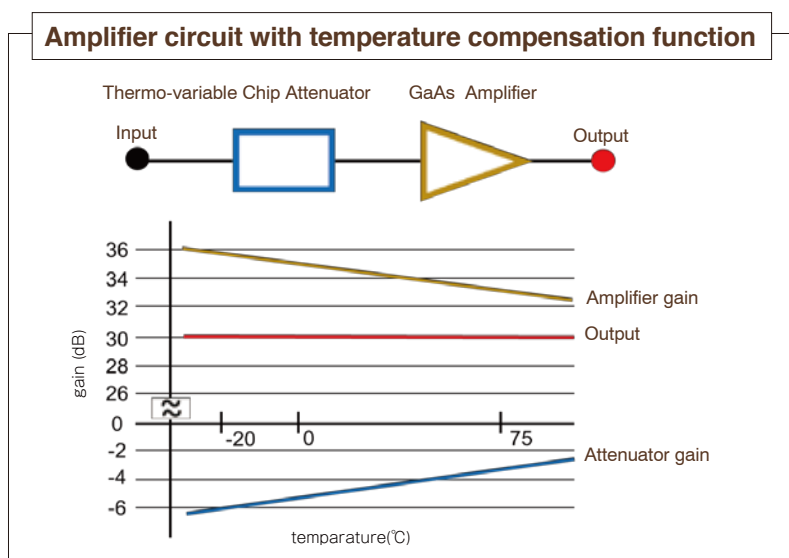



Power Splitter

PS Series

Features

- Resistive type power splitter. Wide frequency range : DC to 20GHz.
- Wide band provides less distortion of square pulses of digital signals
- Small and easy to mount
- Special design and thin film produce less reflection.

Applications

- Communication devices
- Wide band measuring instrumentation



Part numbering system

PS 1608 G T2 - R50 - T1

Series code: PS 1608 G T2 - R50 - T1

Size : PS1608,PS2012
PS3216,PS5025

G : General

Packing quantity: T=Tape (T1/T5), B=Bulk

Impedance : 50Ω

Number of Output terminals

PS 1005 T2 - R50 - FD - T1

Series code: PS 1005 T2 - R50 - FD - T1

Size : PS1005

No GND, Need Face down mounting

Packing quantity: T=Tape (T1/T5), B=Bulk

Impedance : 50Ω

Number of Output terminals

Electrical Specification

Type	PS1005 ※1	PS1608G	PS2012G	PS3216G	PS5025G
Operating frequency	DC - 20GHz	DC - 20GHz	DC - 17.5GHz	DC - 15GHz	DC - 10GHz
Rated power	100mW	100mW	125mW	250mW	500mW
Insertion Loss	6dB±0.5dB				< 10GHz
	6dB±1.0dB				< 7.5GHz
Distribution Deviation		< 0.3dB (Max frequency)			
VSWR	≤1.3				< 10GHz
	≤1.5				< 7.5GHz
Operating temperature		-40°C ~ +125°C			
Packaging quantity		50pcs/bag(B) 1,000pcs/reel(T1) 5,000pcs/reel(T5)			

※1 The PS1005 series has no ground plane.

Equivalent Circuit and pin arrangement

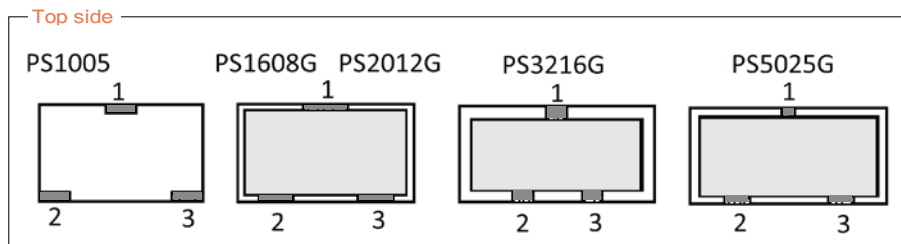
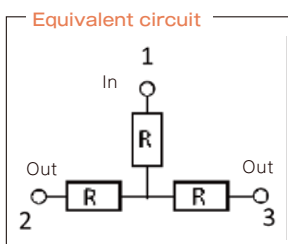

High frequency surface mount components

PS series

◆ Dimensions

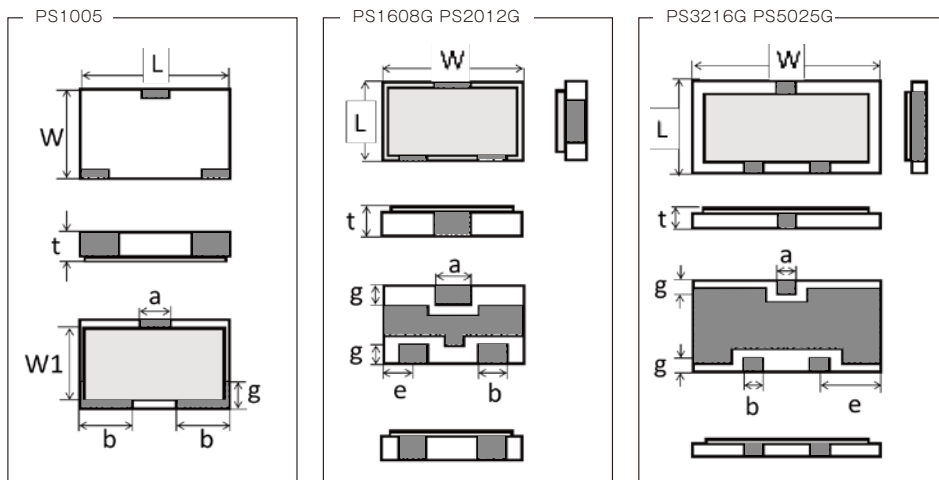

Type	Size (inch)	W	L	t	a	b	e	g
PS1005	0402	1.00±0.10	0.50±0.10	0.30±0.10	0.40±0.10	0.35±0.10	—	0.20±0.10
PS1608G	0603	1.60±0.10	0.80±0.10	0.40±0.10	0.45±0.10	0.35±0.10	0.40±0.10	0.25±0.10
PS2012G	0805	2.00±0.10	1.25±0.10	0.40±0.10	0.45±0.15	0.35±0.15	0.35±0.10	0.25±0.10
PS3216G	1206	3.20±0.10	1.60±0.10	0.40±0.10	0.35±0.10	0.40±0.15	1.075±0.10	0.20±0.10
PS5025G	2010	5.00±0.20	2.50±0.20	0.80±0.20	0.50±0.20	0.75±0.20	1.65±0.20	0.30±0.15

(unit : mm)

◆ Recommended land patterns (soldering footprints)

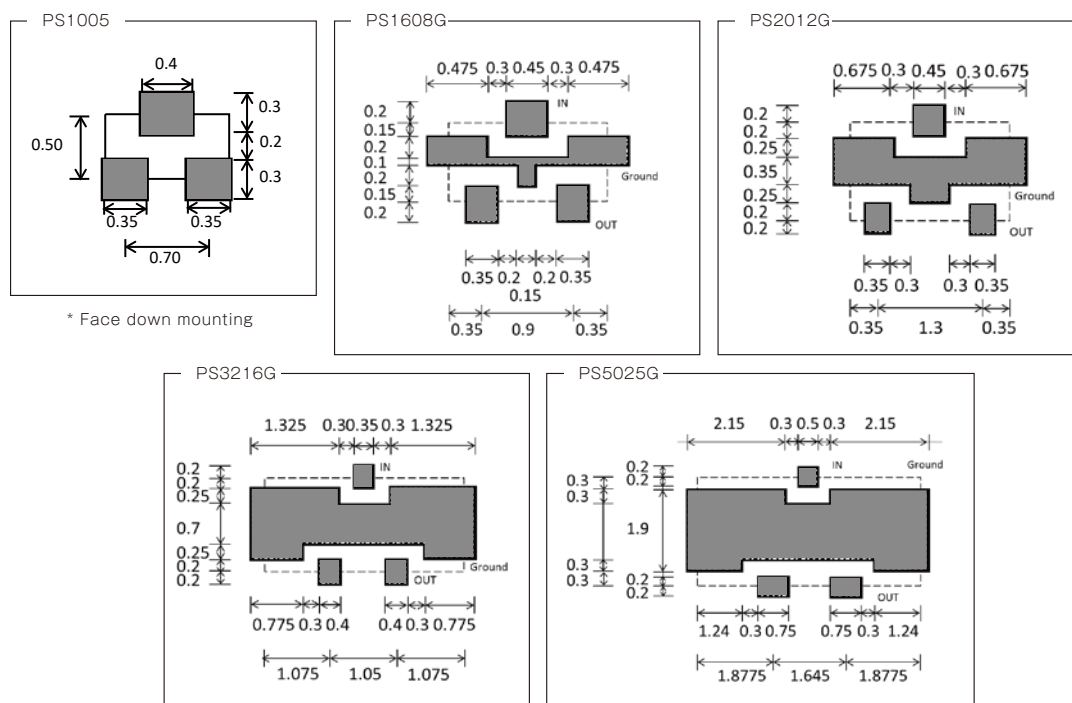

* Face down mounting

◆ Derating Curve

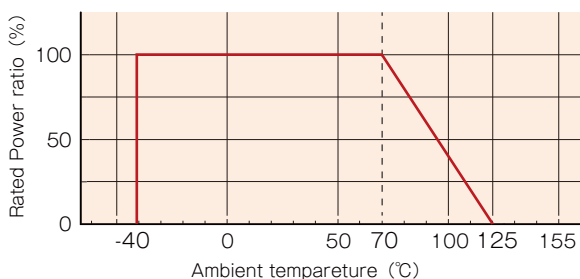

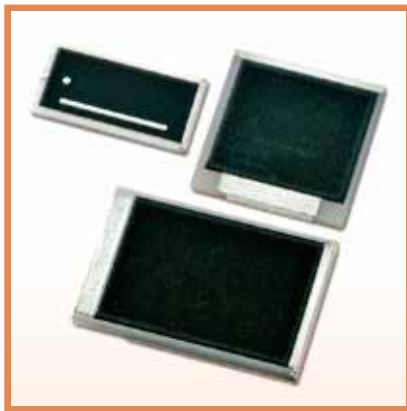

High Power Thin Film Chip Terminator

■ PCS Series、 HPT Series

Features

- Small high power chip terminator with aluminum nitride and aluminum oxide substrate
- Efficient heat dissipation provides high power, anti-surge, overload protection.
- Wrap around terminals provide easy and reliable soldering.
- Thin film does not have any innate stress. Therefore, repeated power cycling does not fatigue the element and cause no change in impedance.

Applications

- Wireless base station, wireless communication devices, and high frequency power source



◆ Part numbering system

HPT 3216 - 50 - T1

Series code(PCS, HPT)

Size : 1005,1608,2012,3216,5025
6432, *6464, *9464H

*HPT series only

Packing quantity:

T=Tape (T1/T5), B=Bulk

Impedance

◆ Electrical Specification

PCS series (Alumina substrate)

Type	PCS1005	PCS1608	PCS2012	PCS3216	PCS5025	PCS6432	
Rated Power	200mW	500mW	1W	2W	5W	10W	
VSWR	DC ~ 3GHz	1.2	1.2	1.2	1.2	1.3	1.2
	3.1~5GHz	1.2	1.2	1.3	1.3	1.4	1.5
	5.1~7.5GHz	1.3	1.3	1.3	1.4	1.5	—
	7.6~10GHz	1.3	1.3	1.4	1.5	—	—
	10.1~12.5GHz	1.4	1.4	1.5	—	—	—
	12.6~15GHz	1.5	1.5	—	—	—	—
Operating temperature	-55°C~ +125°C						
Rated operating temperature	+70°C						
Packaging quantity	100pcs/bag (B) 1000pcs/reel (T1) 5000pcs/reel (T5)						

HPT series (ALN substrate)

Type	HPT1608	HPT2012	HPT3216	HPT5025	HPT6432	HPT6464	HPT9464H
Rated Power	2.5W	5W	10W	20W	30W	60W	100W
VSWR	DC ~ 3GHz	1.2	1.2	1.2	1.3	1.3	1.3
	3.1~5GHz	1.2	1.3	1.3	1.5	1.5	—
	5.1~7.5GHz	1.3	1.3	1.4	—	—	—
	7.6~10GHz	1.3	1.4	1.5	—	—	—
	10.1~12.5GHz	1.4	1.5	—	—	—	—
	12.6~15GHz	1.5	—	—	—	—	—
Operating temperature	-40°C~ +155°C						
Rated operating temperature	+100°C at Terminal						
Packaging quantity	100pcs/bag (B) 1000pcs/reel (T1) 5000pcs/reel (T5)						100pcs/bag (B) 1000pcs/reel (T1)

◆ Dimension, Equivalent Circuit and pin arrangement

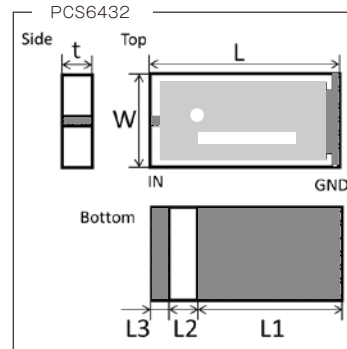
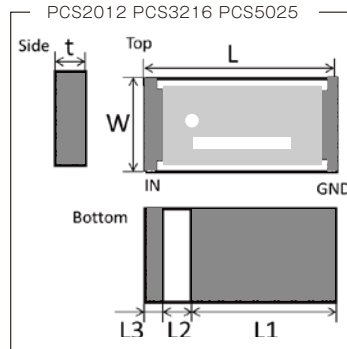
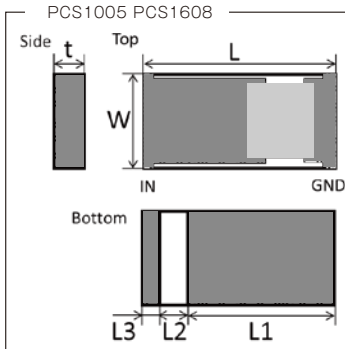
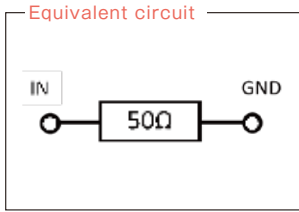

Type	Size (inch)	L	W	t	L1	L2	L3
PCS1005	0402	1.00±0.10	0.50±0.10	0.30±0.10	0.65±0.10	0.20±0.10	0.15±0.10
PCS1608	0603	1.60±0.15	0.80±0.15	0.40±0.10	1.10±0.15	0.30±0.15	0.20±0.15
PCS2012	0805	2.00±0.15	1.25±0.15	0.40±0.10	1.50±0.15	0.30±0.15	0.20±0.15
PCS3216	1206	3.20±0.20	1.60±0.20	0.40±0.10	2.70±0.20	0.30±0.15	0.20±0.15
PCS5025	2010	5.00±0.20	2.50±0.20	0.40±0.10	4.30±0.20	0.40±0.15	0.30±0.15
PCS6432	2512	6.40±0.20	3.20±0.20	0.40±0.10	5.70±0.20	0.40±0.15	0.30±0.15

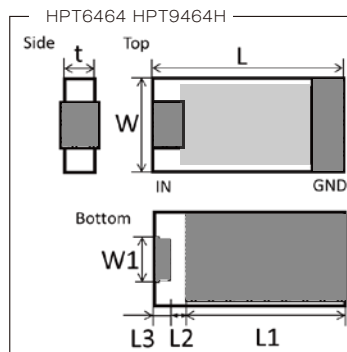
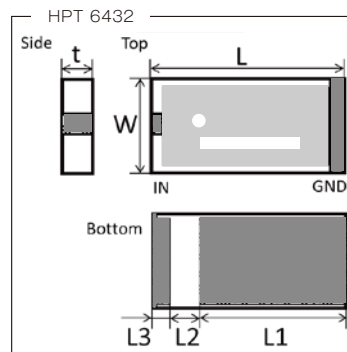
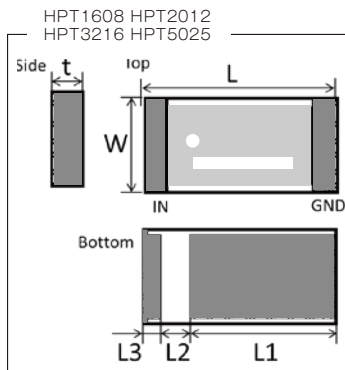

Type	Size (inch)	L	W	t	L1	L2	L3	W1
HPT1608	0603	1.60±0.15	0.80±0.15	0.40±0.10	1.10±0.15	0.30±0.15	0.20±0.15	—
HPT2012	0805	2.00±0.15	1.25±0.15	0.40±0.10	1.50±0.15	0.30±0.15	0.20±0.15	—
HPT3216	1206	3.20±0.20	1.60±0.20	0.40±0.10	2.70±0.20	0.30±0.15	0.20±0.15	—
HPT5025	2010	5.00±0.20	2.50±0.20	0.65±0.10	3.60±0.20	0.90±0.20	0.50±0.15	—
HPT6432	2512	6.40±0.20	3.20±0.20	0.65±0.10	5.50±0.20	0.70±0.15	0.20±0.15	—
HPT6464	2525	6.30±0.20	6.30±0.20	0.65±0.10	4.90±0.20	0.65±0.15	0.75±0.15	3.05±0.20
HPT9464H	3725	9.40±0.20	6.30±0.20	0.65±0.10	7.10±0.20	1.15±0.15	1.15±0.15	3.00±0.20

(unit : mm)

High Power Thin Film Chip Terminator

PCS Series、HPT Series

Recommended land patterns (soldering footprints)

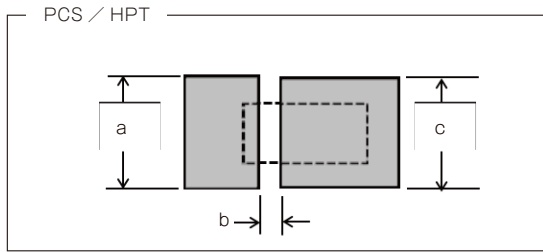

Type	a	b	c
PCS1005	0.70	0.20	0.70
PCS1608	1.20	0.30	1.20
PCS2012	1.20	0.45	1.60
PCS3216	2.00	0.45	2.00
PCS5025	2.90	0.55	2.90
PCS6432	3.60	0.55	3.60

(unit : mm)

Type	a	b	c
HPT1608	1.20	0.40	1.20
HPT2012	1.60	0.40	1.50
HPT3216	2.00	0.40	2.00
HPT5025	2.90	0.90	2.90
HPT6432	3.60	0.70	3.60
HPT6464	3.30	1.15	6.80
HPT9464H	3.30	1.15	6.80

(unit : mm)

Mounting example

Pay special care to heat dissipation when this product is used at maximum rated power.

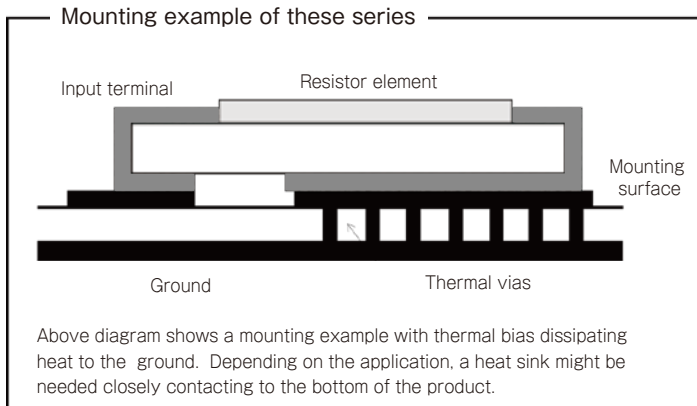

High frequency surface mount components

Derating Curve

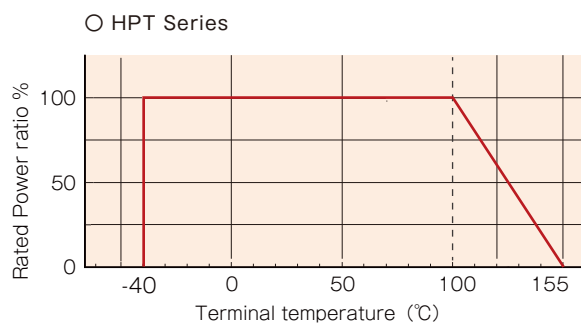
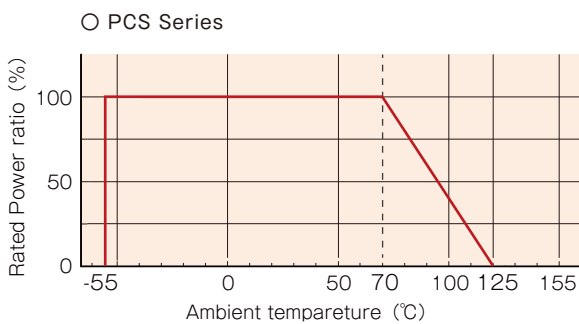

PCS Series, HPT Series

◆ High frequency characteristics

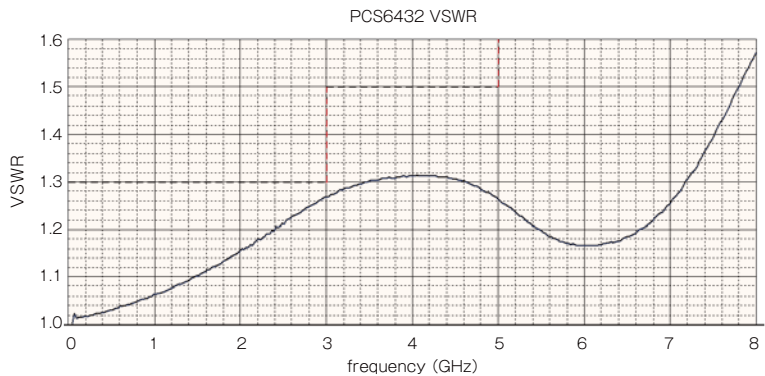
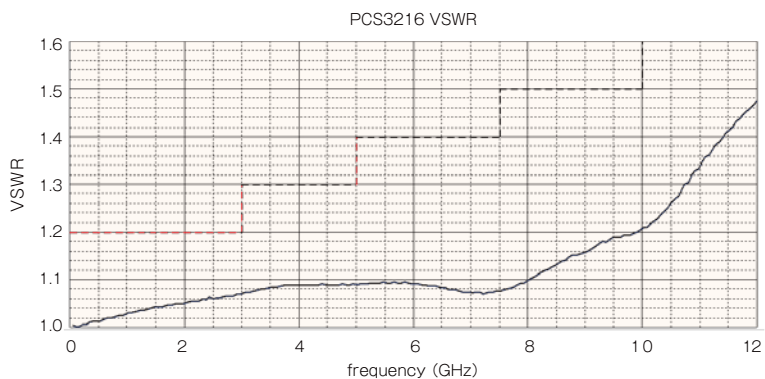
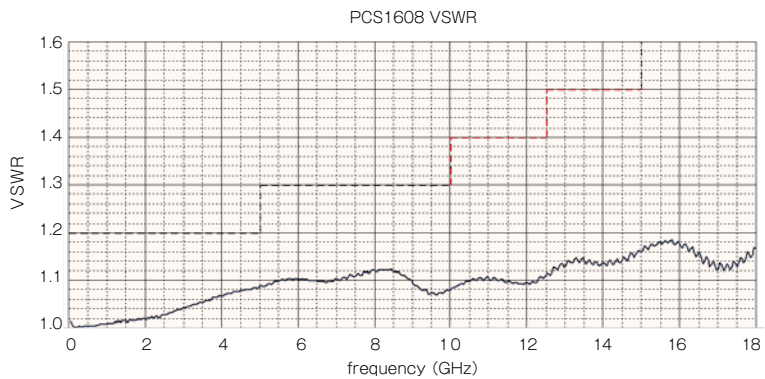

Sample kits

Sample kits



Sample kits

Kits are available for metal thin film chip resistors and low resistance chip resistors.

They are perfect for development, prototype making, testing and experiments.

◆Part numbering system

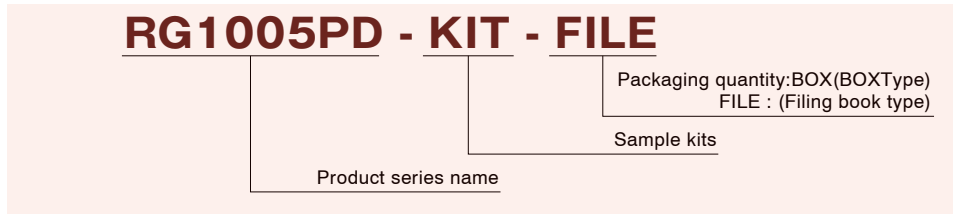

◆Electrical Specification

Surface mount thin film resistors / Metal thin film chip resistors

Electrical characteristics	Rated power(W)						Resistance tolerance(%)			Container type
	1/4	1/6	1/8	1/10	1/16	1/32	±0.05	±0.1	±0.5	FILE
RR0816PD-KIT					●				●	●
RR1220PD-KIT				●					●	●
RG1005PD-KIT			●		●	●			●	●
RG1608PD-KIT		●		●	●				●	●
RG2012PD-KIT	●		●	●					●	●
RG1005PB-KIT			●		●	●		●		●
RG1608PB-KIT		●		●	●			●		●
RG2012PB-KIT	●		●	●				●		●
RG1005NW-KIT			●		●	●	●			●
RG1608NW-KIT		●		●	●		●			●
RG2012NW-KIT	●		●	●			●			●

Current sensing surface mount resistors / Low resistance chip resistors

Electrical characteristics	Rated power(W)										Resistance tolerance(%)		Container type
	6	5	4	3	2	1.5	1	3/4	1/2	1/3	±1	±2	FILE
KRL1220-KIT									●		●	●	●
KRL1632-KIT								●			●	●	●
KRL3264-KIT				●							●	●	●
KRL2012-KIT							●				●	●	●
KRL3216-KIT						●					●	●	●
KRL6432-KIT				●							●	●	●
KRL7638-KIT			●								●	●	●
KRL9045-KIT		●									●	●	●
KRL11050-KIT	●										●	●	●
RL1220-KIT										●	●		●
RL3720W-KIT							●				●		●

Sample kits

Standard Specification for surface mount chip resistors

This standard specification describes shared specifications among surface mount chip resistors regarding placement and packaging.

Custom products and products in development may not be included in these specifications.

Contact our sales office for these products.

These specifications may not be applicable to power choke products and high frequency components. Contact our sales office for these products.

1. Recommended land patterns (soldering footprints)

- ① For thin film chip resistor
- ② For current sensing chip resistor

2. Recommended reflow and flow soldering profile

3. Dimensions of the packaging tape

- ① For thin film chip resistor
- ② For current sensing chip resistor

4. Dimensions of the packaging reel

Recommended land patterns (soldering footprints)

① For thin film chip resistor

【Applicable series】

- URG series · RG series · RGT series · RGV series · NRG series
- MRG series · RGA series^{*1} · RS series · RR series · RT series

Recommended land dimensions (mm)			
Sizes	a	b	c
0603	0.28	0.76	0.34
1005	0.5	1.6	0.6
1608	1.0	3.0	1.2
2012	1.2	4.0	1.65
3216	2.2	5.0	2.0
3225	2.2	5.5	2.9
5025	3.8	6.8	2.9
6432	4.8	8.2	3.6

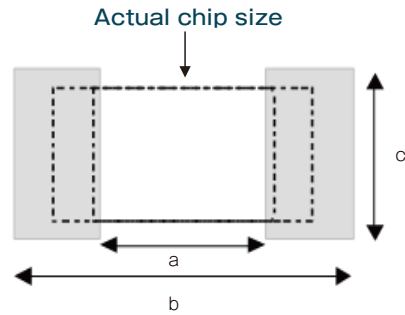

*1 RGA is compatible with conductive epoxies.
Please contact our sales office for details for conductive epoxy usage.

【Applicable series】

- PRG series

Recommended land dimensions (mm)				
Sizes	a	b	c	d ^(*) (reference)
2010	0.5	0.6	2.5	≥27
3216	0.8	1.1	3.7	≥27
5025	1.2	1.4	5.5	≥27
6432	2	2.1	6.9	≥27

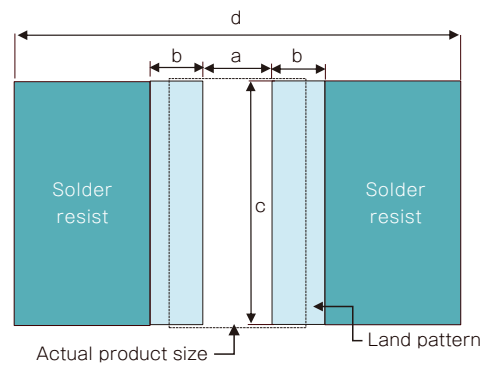

*1 Please design the land pattern considering heat dissipation to the board so that the terminal temperature will not exceed 155°C.

【Applicable series】

- HRG series

Recommended land dimensions (mm)				
Sizes	a	b	c	d ^(*) (reference)
3216	0.55	1.9	1.8	≥27

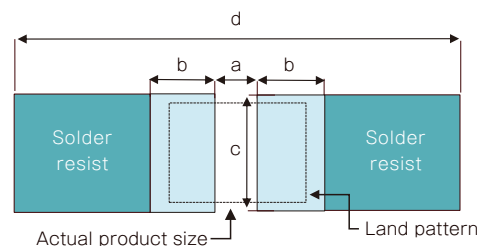

*1 Please design the land pattern considering heat dissipation to the board so that the terminal temperature will not exceed 155°C.

【Applicable series】

· RM series^{*1} · RMA series^{*2}

○ 4 terminal type

Recommended land dimensions (mm)						
Sizes	a	b	c	d	e	f
RM/RMA2012	0.6 ~ 0.7	1.6 ~ 1.8	0.4 ~ 0.6	1.8 ~ 2.0	0.7 ~ 0.9	1.3 ~ 1.5
RM/RMA3216	0.6 ~ 0.8	2.4 ~ 2.7	0.6 ~ 0.8	2.6 ~ 3.2	1.4 ~ 1.6	2.2 ~ 2.4
RM/RMA3225	1.5 ~ 1.7	3.3 ~ 3.6	0.6 ~ 0.8	2.6 ~ 3.2	1.4 ~ 1.6	2.2 ~ 2.4

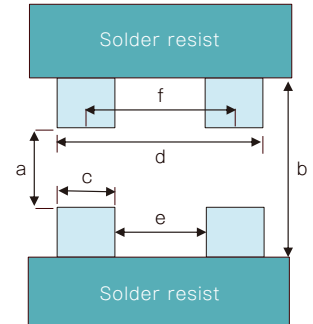

○ 6 terminal type

Recommended land dimensions (mm)						
Sizes	a	b	c	d	e	f
RM3216	0.5 ~ 0.7	2.4 ~ 2.7	0.6 ~ 0.8	2.5 ~ 2.7	0.2 ~ 0.3	0.9 ~ 1.0
RM3225	1.3 ~ 1.5	3.3 ~ 3.6	0.6 ~ 0.8	2.5 ~ 2.7	0.2 ~ 0.3	0.9 ~ 1.0

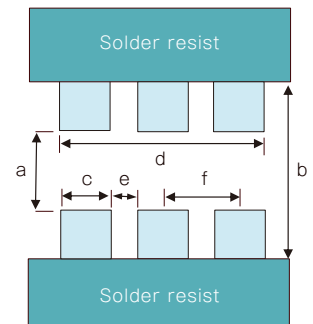

○ 8 terminal type

Recommended land dimensions (mm)						
Sizes	a	b	c	d	e	f
RM3216	0.7 ~ 0.8	2.2 ~ 2.3	0.4 ~ 0.45	2.9 ~ 3.0	0.3 ~ 0.35	0.8 ~ 0.85
RM3225	1.4 ~ 1.5	3.4 ~ 3.5	0.4 ~ 0.45	2.9 ~ 3.0	0.3 ~ 0.35	0.8 ~ 0.85
RM6432	1.9 ~ 2.0	4.0 ~ 4.1	0.85 ~ 0.9	5.7 ~ 5.8	0.7 ~ 0.75	1.6 ~ 1.65

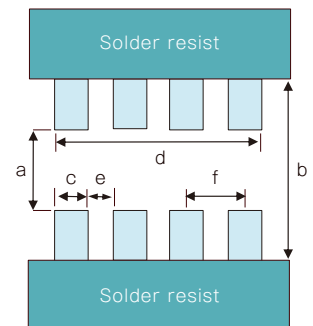

*1 Custom RM requires custom land patterns. Please contact us.

*2 RMA is compatible with conductive epoxies. Please contact our sales office for details for conductive epoxy usage.

Recommended land patterns (soldering footprints)

② For current sensing chip resistor

[Applicable series]

· KRL series (long side terminal)

Recommended land dimensions (mm)					
Types	Resistance range	Copper foil thickness (um)	a	b	c
KRL1608D	10mΩ~		0.25	1.60	1.70
KRL2012D/E	1mΩ ^{*1}	100	0.25	2.00	2.20
	2mΩ~	35	0.60		
KRL3216D/E	1mΩ ^{*1}	100	0.40	2.40	3.40
	2mΩ~	35	0.60		
KRL5025D/E	1mΩ ^{*1}	35	0.70	4.00	5.20
	2mΩ~		1.20		
KRL6432D/E	1mΩ ^{*1}	100	0.70	4.20	6.60
	2mΩ~		2.20		
KRL7638D/E	1mΩ ^{*1}	100	1.10	4.60	7.80
	2mΩ~		2.60		
KRL9045D/E	1mΩ ^{*1}	100	1.30	5.10	9.20
	2mΩ~		3.10		
KRL11050D/E	1mΩ ^{*1}	100	1.80	5.60	11.20
	2mΩ~		3.60		
KRL15075D/E	1mΩ ^{*1}	100	2.00	8.40	15.20
	2mΩ~		5.00		

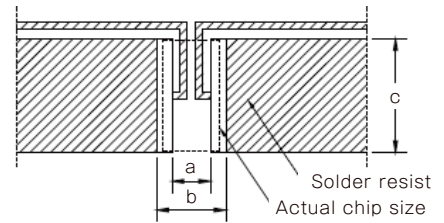

*1 KRL2012D/E, KRL3216D/E, KRL5025D/E, KRL6432D/E, KRL7638D/E, KRL9045D/E, KRL11050D/E, KRL15075D/E : 1mΩ

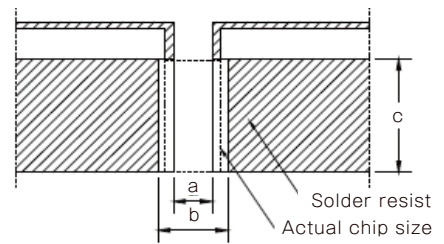

*1 Refer to the diagram right for the Land pattern of 1mΩ

[Applicable series]

· KRL series (Short side terminal)

Recommended land dimensions (mm)					
Types	Resistance range	Copper foil thickness (um)	a	b	c
KRL0816D/E	10~18mΩ ^{*1}	35	0.10	2.20	1.00
	20~39mΩ ^{*1}		0.50		
	43mΩ~	100	0.90		
KRL1220D/E	5mΩ~	100	1.20	2.70	1.50
KRL1632D/E	5~8mΩ		1.00	4.00	1.90
	9mΩ~	2.00			
KRL2550D/E	5~8mΩ	100	2.20	6.00	2.80
	9mΩ~		3.80		
KRL3264D/E	5~8mΩ	100	2.50	7.40	3.50
	9mΩ~		4.40		
KRL50110D/E	5~8mΩ	100	2.80	14.00	5.75
	9mΩ~		5.50		

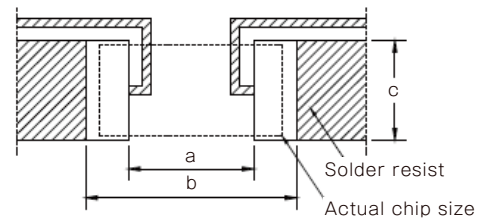

*1 KRL0816D/E : 10 ~ 18mΩ, 20 ~ 39mΩ

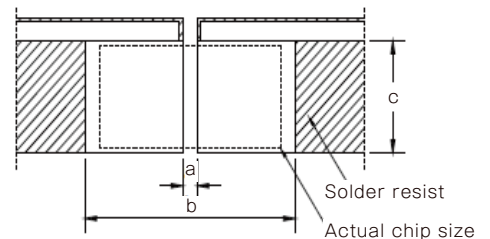

*1 Refer to the diagram right for the land pattern of KRL0816D/E

【Applicable series】

· KRL series (4terminal type)

Recommended land dimensions (mm)					
Types	a	b	c	d	e
KRL3216T4	0.40	2.70	0.35	0.30	2.70
KRL6432T4	2.00	4.40	0.70	0.50	5.40
KRL7638T4	2.00	4.40	1.00	0.60	6.30
KRL9045T4	2.60	5.00	1.20	0.70	7.50
KRL11050T4	3.20	5.60	1.60	1.10	8.70

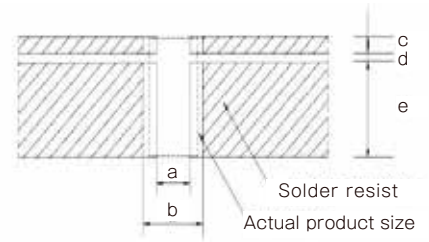

【Applicable series】

· RL Series (Short side terminal)

Recommended land dimensions (mm)			
Sizes	a	b	c
0510	0.5	1.9	0.7
0816	0.7	3.0	1.6
1220	1.0	4.0	2.4

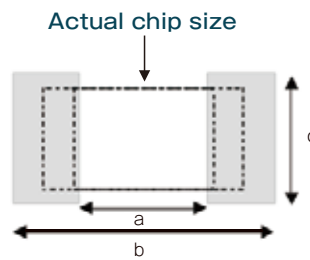

【Applicable series】

· RL Series (Short side terminal)

Recommended land dimensions (mm)				
Sizes	a	b	c	d
RL3720W	1.2	7.9	7.9	27.0
RL7520W	1.2	15.8	15.8	27.0

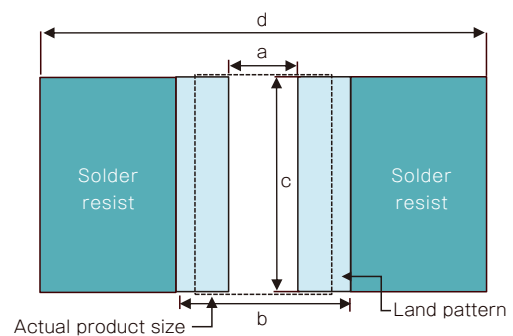

Recommended land patterns (soldering footprints)

Standard specification

Recommended reflow and flow soldering profile

Recommended reflow soldering profile

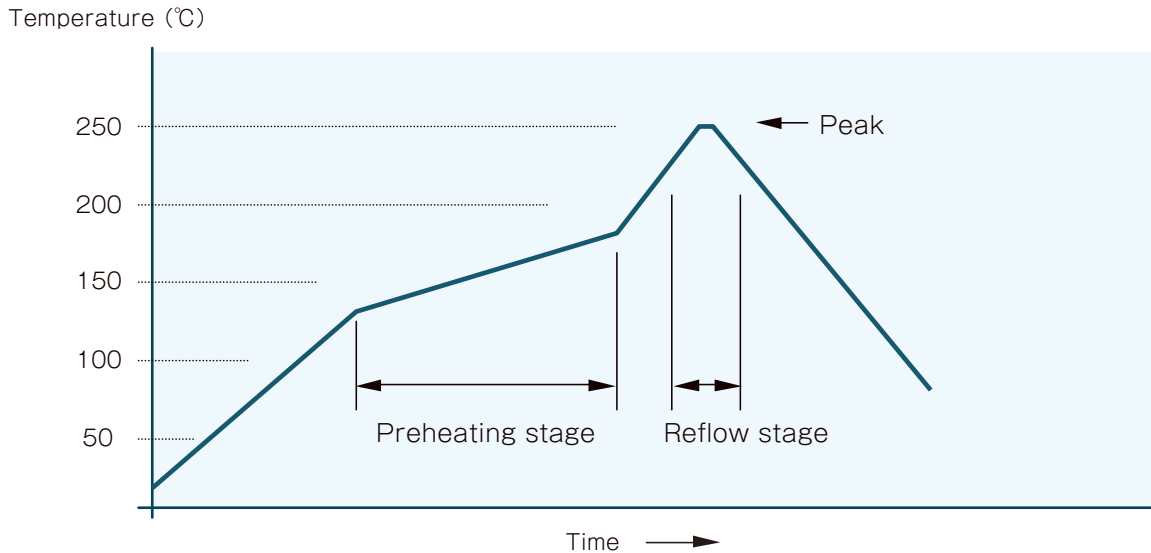

Product surface temperature

pre-heating	130 ~ 180°C 60 ~ 90sec.
Reflow	above 220° 30 ~ 90sec.
Peak temperature	240 ~ 250°C aximum 10 seconds · Applicable solder composition : Sn-Ag-Cu solder paste · Cycles : twice (cooling between 1st and 2nd cycles)

Recommended flow soldering profile

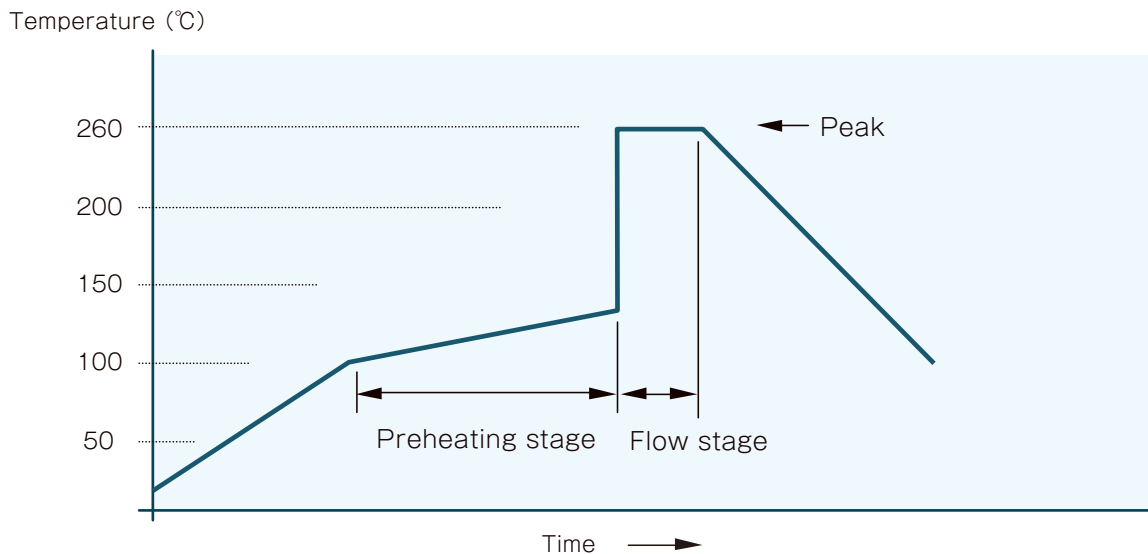

Product surface temperature

pre-heating	100°C~ 120°C 60 ~ 80 sec
Peak temperature	255°C~ 265°C aximum 5 seconds · Applicable solder composition : Sn-Ag-Cu solder paste · Cycles : twice

Dimensions of the packaging tape

① For thin film chip resistor

Tape dimensions (paper 2 mm pitch)

Types	a	b	T
RR0306/ RT0603	0.38±0.03	0.68±0.03	0.31±0.02
RR/RT0510	0.63±0.05	1.13±0.05	0.43±0.05
RG/RGT/NRG/ RS/RGA1005	0.63±0.05	1.13±0.05	0.43±0.05
RL0510	0.63±0.05	1.13±0.05	0.43±0.05

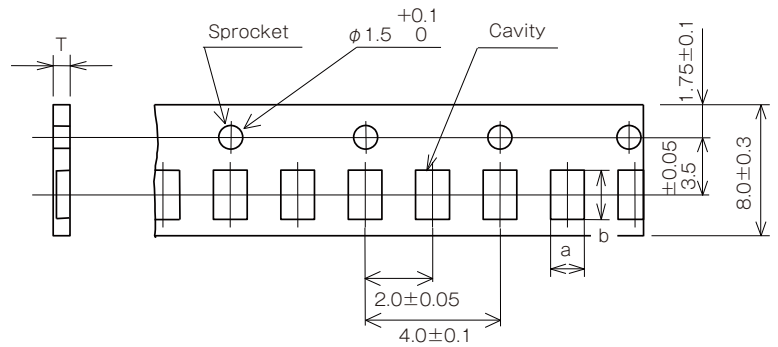

Tape dimensions (paper 4 mm pitch)

Types	a	b	T
RR/RT/0816	1.1±0.1	1.9±0.1	0.6±0.05
URG/RG/RGT NRG/RGA1608	1.1±0.1	1.9±0.1	0.6±0.05
RL0816	1.1±0.1	1.9±0.1	0.6±0.05
RR/RT1220	1.65±0.2	2.4±0.2	0.75±0.05
URG/RG/RGT/MRG/ NRG/RGA2012	1.65±0.2	2.4±0.2	0.75±0.05
RL1220	1.65±0.2	2.4±0.2	0.75±0.05

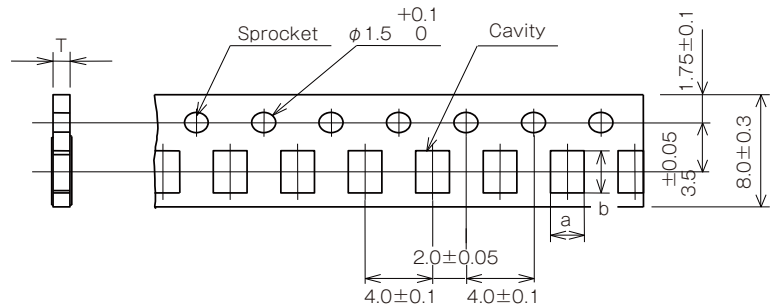

Tape dimension (embossed tape 4mm pitch)

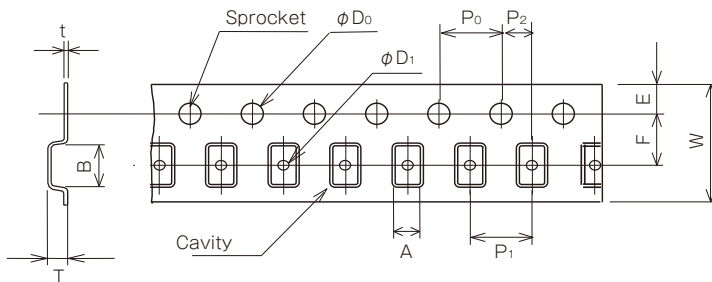

Types	A	B	W	F	E	P ₀	P ₁	P ₂	φD ₀	φD ₁	T	t
RM2012	1.6±0.2	2.4±0.2	8.0±0.3	3.5±0.05	1.75±0.1	4.0±0.1	4.0±0.1	2.0±0.05	1.55±0.05	1.05±0.05	1.0±0.1	0.3max
URG/RG/RGT RGV/NRG 3216	2.0±0.2	3.6±0.2	8.0±0.3	3.5±0.05	1.75±0.1	4.0±0.1	4.0±0.1	2.0±0.05	1.55±0.05	1.05±0.05	1.0±0.1	0.3max
PRG/HRG/MRG RM/RMA3216	2.0±0.2	3.6±0.2	8.0±0.3	3.5±0.05	1.75±0.1	4.0±0.1	4.0±0.1	2.0±0.05	1.55±0.05	1.05±0.05	1.0±0.1	0.3max
RGV/RM/RMA 3225	2.8±0.1	3.5±0.1	8.0±0.3	3.5±0.05	1.75±0.1	4.0±0.1	4.0±0.1	2.0±0.05	1.55±0.05	1.1±0.1	1.0±0.1	0.3max
PRG 5025	2.8±0.1	5.3±0.1	12.0±0.2	5.5±0.05	1.75±0.1	4.0±0.1	4.0±0.1	2.0±0.05	1.55±0.05	1.1±0.1	1.0±0.1	0.3max
URG/MRG 5025	2.8±0.1	5.3±0.1	12.0±0.2	5.5±0.05	1.75±0.1	4.0±0.1	4.0±0.1	2.0±0.05	1.55±0.05	1.1±0.1	1.0±0.1	0.3max
PRG/RM 6432	3.5±0.2	6.9±0.2	12.0±0.2	5.5±0.05	1.75±0.1	4.0±0.1	4.0±0.1	2.0±0.05	1.55±0.05	1.50±0.1/-0	1.0±0.1	0.3max

Dimensions of the packaging tape

② For current sensing chip resistor

Tape dimensions (embossed tape)

○ 4 mm pitch , 8 mm pitch,

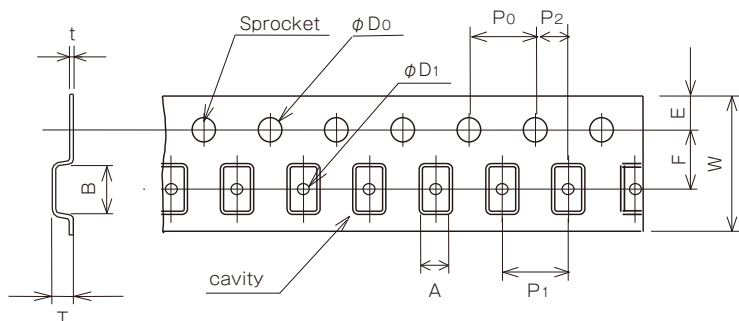

Types	A	B	W	F	E	P ₀	P ₁	P ₂	φD ₀	φD ₁	T	t
KRL0816/1608 YJP1608	0.95±0.05	1.85±0.05	8.0±0.1	3.5±0.05	1.75±0.1	4.0±0.1	4.0±0.1	2.0±0.05	1.5+0.1/-0	0.6±0.05	0.55±0.05	0.2±0.05
KRL1220 /2012	1.45±0.05	2.3±0.1	8.0±0.2/-0	3.5±0.05	1.75±0.1	4.0±0.1	4.0±0.1	2.0±0.05	1.5+0.1/-0	-	0.65±0.1	0.2±0.05
KRL1632 /3216	1.9±0.1	3.5±0.1	8.0±0.2	3.5±0.05	1.75±0.1	4.0±0.1	4.0±0.1	2.0±0.05	1.5+0.1/-0	1.0+0.2/-0	0.75±0.1	0.2±0.05
KRL2550 /5025	2.9±0.2	5.3±0.2	12.0±0.3	5.5±0.05	1.75±0.1	4.0±0.1	4.0±0.1	2.0±0.05	1.5+0.1/-0	1.5+0.2/-0	1.5max	0.3max
KRL3264/6432 KRL6432T4	3.43±0.2	6.63±0.2	12.0±0.3	5.5±0.05	1.75±0.1	4.0±0.1	4.0±0.1	2.0±0.05	1.5+0.1/-0	1.5+0.2/-0	0.76±0.1	0.2±0.05
KRL7638 KRL7638T4	4.15±0.1	7.95±0.1	16.0±0.3	7.5±0.1	1.75±0.1	4.0±0.1	8.0±0.1	2.0±0.1	1.5±0.1	1.5±0.1	1.2±0.15	0.3±0.05
KRL9045 KRL9045T4	4.85±0.1	9.35±0.1	16.0±0.3	7.5±0.1	1.75±0.1	4.0±0.1	8.0±0.1	2.0±0.1	1.5±0.1	1.5±0.1	1.2±0.15	0.3±0.05
KRL50110 /11050 KRL11050T4	5.4±0.1	11.5±0.1	24.0±0.3	11.5±0.1	1.75±0.1	4.0±0.1	8.0±0.1	2.0±0.1	1.5±0.1	1.5±0.1	1.2±0.15	0.3±0.05

Types	A	B	W	F	E	P ₀	P ₁	P ₂	φD ₀	φD ₁	T	t
SHR6432	3.5±0.2	6.9±0.2	12.0±0.2	5.5±0.1	1.75±0.1	4.0±0.1	4.0±0.1	2.0±0.1	1.50+0.1/-0	1.50+0.1/-0	0.75±0.1	0.3max

Types	A	B	W	F	E	P ₀	P ₁	P ₂	φD ₀	φD ₁	T	t
RL3720W	2.6±0.2	4.45±0.2	12.0±0.2	5.5±0.05	1.75±0.1	4.0±0.1	4.0±0.1	2.0±0.05	1.55±0.05	-	0.7±0.1	0.3±0.05
RL7520W	2.6±0.2	8.2±0.2	16.0±0.3	7.5±0.1	1.75±0.1	4.0±0.1	4.0±0.1	2.0±0.1	1.55±0.05	-	0.7±0.1	0.3±0.05

Dimensions of the packaging reel

【Applicable series】

- URG series · RG series · RGT series · RGV series · NRG series · RS series · PRG series
- HRG series · MRG series · RGA series · RRseries · RT series · RM series · RMA series

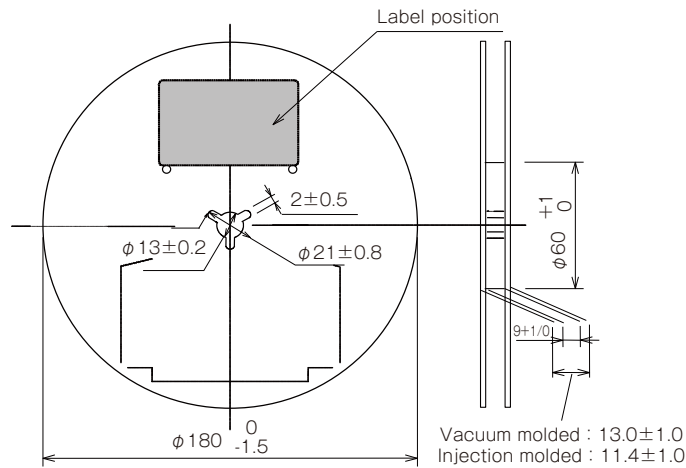

【Applicable series】

- KRL series (long side terminal) · KRL series (short side terminal) · KRL series (4 terminals) · YJP series

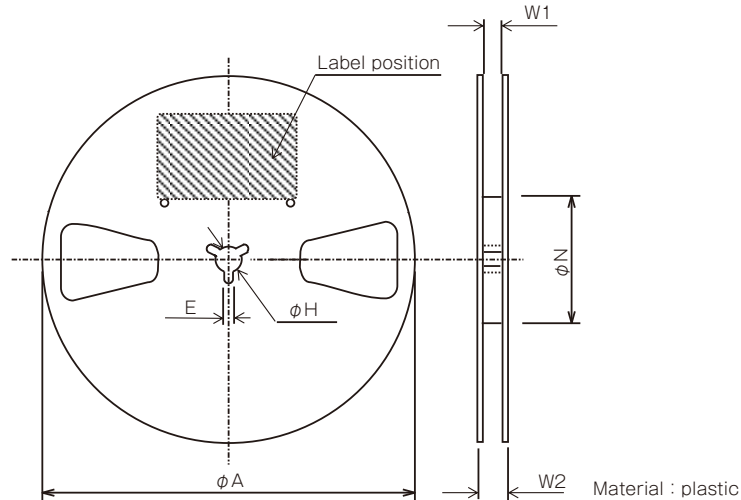

Sizes	pieces / reel	ϕA	ϕH	E	ϕN	W1	W2
0816/1608 1220/2012 1632/3216	1,000/5,000	$180+0/-3.0$	13 ± 0.2	2 ± 0.5	$60+1.0/-0.0$	9 ± 0.3	13 ± 1.4
2550/5025 3264/6432	1,000 5,000	$180+0/-3.0$ 255 ± 1.0	13 ± 0.2 13 ± 0.2	2 ± 0.5 2 ± 0.5	$60+1.0/-0.0$ 80 ± 0.5	13 ± 0.3 13.5 ± 1.0	17 ± 1.4 ≤ 18.4
7638 9045	1,000 5,000	$180+0/-3.0$ 330 ± 2.0	13 ± 0.2 13 ± 0.2	2 ± 0.5 2 ± 0.5	$60+1.0/-0.0$ 80 ± 1.0	17.0 ± 0.3 17.4 ± 1.0	19.4 ± 1.0 21.4 ± 1.0
50110/11050	1,000	$180+0/-3.0$	13 ± 0.2	2 ± 0.5	80 ± 1.0	25.4 ± 1.0	29.4 ± 1.0

Standard Specification for High frequency surface mount components

This standard specification describes shared specifications among high frequency surface mount components regarding mounting and packaging.

However, since the land pattern differs depending on each series, please refer to the contents of each series description.

Custom products and products in development may not be included in these specifications.

Please contact our sales office for these products

- 1. Recommended reflow soldering profile**
- 2. Dimensions of the packaging tape**
- 3. Dimensions of the packaging reel**

Recommended reflow soldering profile

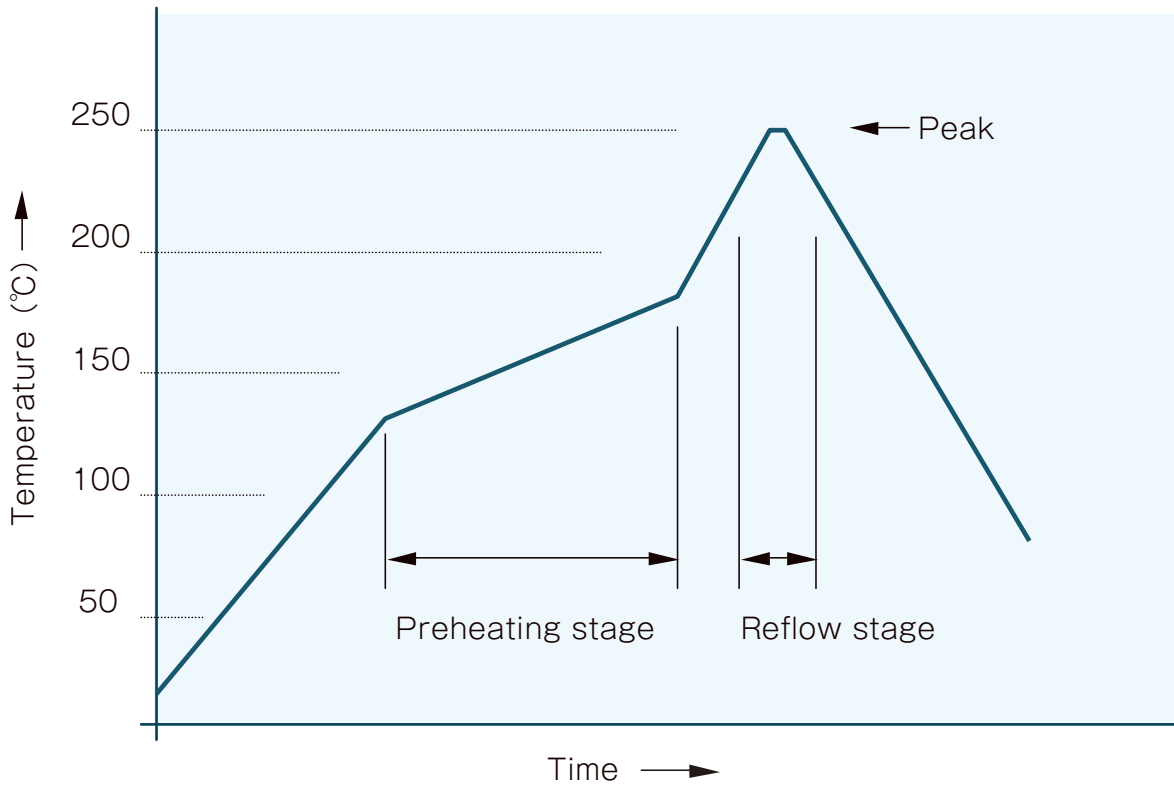

Product surface temperature

pre-heating	130 ~ 180°C 60 ~ 90sec.
Reflow	above 220°C 30 ~ 90sec.
Peak temperature	240 ~ 250°C Maximum 10 seconds · Applicable solder composition : Sn - Ag - Cu solder paste · Cycles : twice (cooling between 1st and 2nd cycles)

* Regarding the reflow soldering profiles of PXV series and PBV series, Please contact our sales office.

Dimension of the packaging tape

For high frequency components

Tape dimensions

Fig.1 Paper 2mm pitch

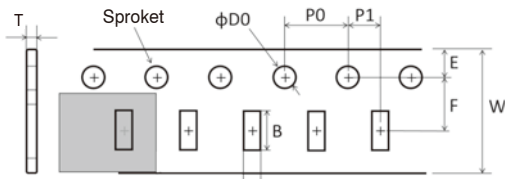

Fig. 2 Embossed tape 4mm

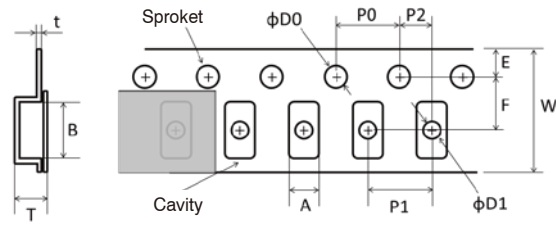
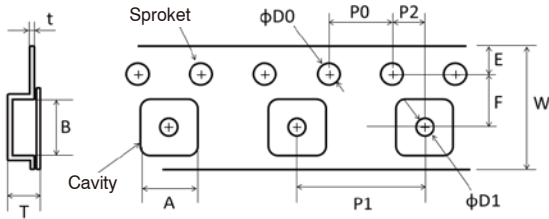

Fig.3 Embossed tape 8mm pitch



Type	Refer fig.	A	B	W	F	E	P0	P1	P2	D0	D1	T	t
ATS Series													
ATS2012	2	1.60±0.20	2.40±0.20	8.00±0.30	3.50±0.05	1.75±0.10	4.00±0.10	4.00±0.10	2.00±0.05	1.55±0.05	—	1.5max	0.30max
PAT Series													
PAT0510S	1	0.65±0.03	1.15±0.03	8.00±0.30	3.50±0.05	1.75±0.10	4.00±0.10	2.00±0.05	—	1.5±0.1/-0	—	0.50±0.10	—
PAT0816	2	0.95±0.05	1.85±0.05					4.00±0.10	—		0.60±0.05	0.55±0.05	0.20±0.05
PAT1220	2	1.45±0.10	2.30±0.10					2.00±0.05	—		0.65±0.01	0.20±0.05	
PAT1632	2	2.00±0.20	3.60±0.20					—	2.5max		0.3max		
PAT3042S	3	3.5±0.20	4.60±0.20	12.00±0.30	5.50±0.05	—	8.00±0.10	—	1.6max	0.4max			
PAT Series, W type													
PAT3042	3	3.50±0.20	4.60±0.20	12.00±0.30	5.50±0.05	1.75±0.10	4.00±0.10	8.00±0.10	2.00±0.05	1.5±0.1/-0	—	1.6max	0.3max
PAT4556	3	4.90±0.10	6.10±0.10					4.00±0.10			1.05±0.05	1.60±0.10	0.30±0.05
PAT3080H	2	3.43±0.20	6.63±0.20					4.00±0.10			1.5±0.2/-0	1.5max	0.20±0.05
P*V Series													
PXV1220S	2	1.45±0.10	2.30±0.10	8.00±0.30	3.50±0.05	1.75±0.10	4.00±0.10	4.00±0.10	2.00±0.05	1.5±0.1/-0	1.0±0.2/-0	1.30±0.20	0.25±0.05
PBV1632S	2	2.00±0.20	3.60±0.20								—	—	0.3max
PAV3137S	3	3.30±0.10	4.30±0.10	12.00±0.30	5.50±0.05	—	8.00±0.05	—	1.5±0.1/-0	1.55±0.10	0.20±0.05		
PS Series													
PS1005	1	0.65±0.03	1.15±0.03	8.00±0.30	3.50±0.05	1.75±0.10	4.00±0.10	2.00±0.05	—	1.5±0.1/-0	—	—	0.50±0.10
PS1608	2	0.95±0.05	1.85±0.05					4.00±0.10	—		0.06±0.10	0.55±0.05	0.20±0.05
PS2012	2	1.60±0.20	2.40±0.20					2.00±0.05	—		1.5max	0.3max	
PS3216	2	1.90±0.10	3.50±0.10					—	1.05±0.05		1.00±0.20	0.20±0.05	
PS5025	2	2.90±0.10	5.30±0.10	12.00±0.30	5.50±0.05	—	—	1.5±0.2/-0	1.00±0.05	0.20±0.05			
PCS Series													
PCS1005	1	0.66±0.03	1.18±0.03	8.00±0.30	3.50±0.05	1.75±0.10	4.00±0.10	2.00±0.05	—	1.5±0.1/-0	—	—	0.50±0.10
PCS1608	2	0.95±0.05	1.85±0.05					4.00±0.10	—		0.60±0.10	0.55±0.05	0.20±0.05
PCS2012	2	1.45±0.10	2.30±0.10					2.00±0.05	—		0.65±0.10	0.20±0.05	
PCS3216	2	1.90±0.10	3.50±0.10					—	1.0±0.2/-0		0.80±0.10	0.20±0.05	
PCS5025	2	2.90±0.10	5.35±0.10	12.00±0.30	5.50±0.05	—	—	4.00±0.10	2.00±0.05	1.5±0.1/-0	1.0±0.2/-0	0.75±0.10	0.20±0.05
PCS6432	2	3.43±0.20	6.63±0.20					4.00±0.10	2.00±0.05		1.0±0.2/-0	1.5max	0.20±0.05
HPT Series													
HPT1608	2	0.95±0.05	1.85±0.05	8.00±0.30	3.50±0.05	1.75±0.10	4.00±0.10	4.00±0.10	2.00±0.05	1.5±0.1/-0	0.60±0.10	0.55±0.05	0.20±0.05
HPT2012	2	1.45±0.10	2.30±0.01								—	0.65±0.10	0.20±0.05
HPT3216	2	1.90±0.10	3.50±0.01	12.00±0.30	5.50±0.05	—	—	—	—	1.5±0.1/-0	1.0±0.2/-0	0.75±0.10	0.20±0.05
HPT5025	2	2.90±0.2	5.30±0.20								1.5±0.2/-0	1.5max	0.3max
HPT6432	2	3.43±0.20	6.63±0.20								1.5±0.2/-0	0.76±0.10	0.20±0.05
HPT6464	3	6.60±0.10	6.70±0.10	16.0±0.3/-0.1	7.50±0.10	—	—	8.00±0.10	2.0±0.10	—	1.5±0.2/-0	1.55±0.10	0.30±0.05
HPT9464	3	6.73±0.10	9.80±0.10					1.5±0.2/-0	0.79±0.10		0.279±0.02		

(unit : mm)

Dimensions of the packaging tape

Standard specification

Dimension of the packaging reel

For high frequency components

Reel dimensions

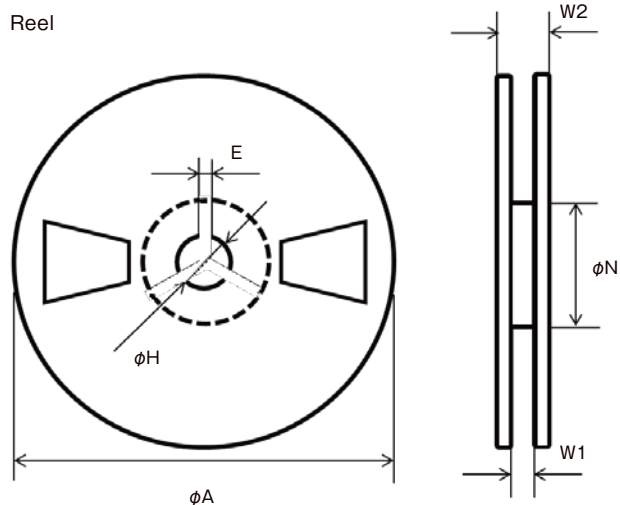

Reel size	ϕA	ϕH	E	ϕN	W1	W2
Size 1	180+0/-3	13.0±0.2	2.0±0.5	60+1/-0	9±0.3	13.0±1.4
Size 2	180+0/-3	13.0±0.2	2.0±0.5	60+1/-0	13.0±0.3	17.0±1.4
Size 3	255±1.0	13.0±0.3	2.0±0.2	80±0.5	13.5±1.0	max 18.4
Size 4	330±2.0	13.0±0.2	2.0±0.5	100±0.5	25.4±1.0	29.4±1.0

(unit : mm)

Type	Packaging Q'ty/reel	Reel size
PAT Series		
PAT0510S	10,000	Size 1
PAT0816	1,000/5,000	Size 1
PAT1220	1,000/5,000	Size 1
PAT1632	1,000/5,000	Size 1
PAT3042S	1,000/2,000	Size 2
PAT Series, W type		
PAT3042	1,000	Size 2
PAT4556	1,000	Size 2
PAT3080H	1,000	Size 2
P*V Series		
PXV1220S	1,000	Size 1
PBV1632S	1,000	Size 1
PAV3137S	1,000	Size 1
PS Series		
PS1005	1,000/5,000	Size 1
PS1608	1,000/5,000	Size 1
PS2012	1,000/5,000	Size 1
PS3216	1,000/5,000	Size 1
PS5025	1,000/5,000	Size 3

Type	Packaging Q'ty/reel	Reel size
PCS Series		
HPT1608	1,000/5,000	Size 1
HPT2012	1,000/5,000	Size 1
HPT3216	1,000/5,000	Size 1
HPT5025	1,000/5,000	Size 1
HPT6432	1,000/5,000	Size 1
HPT6464	1,000	Size 1
HPT9464	5,000	Size 3
HPT Series		
HPT1608	1,000/5,000	Size 1
HPT2012	1,000/5,000	Size 1
HPT3216	1,000/5,000	Size 1
HPT5025	1,000	Size 2
HPT6432	1,000	Size 2
HPT6464	5,000	Size 3
HPT9464	1,000	Size 4

Sales offices - ASIA -

ASIA

Exer Technologies Pte.
Sales Office: Singapore, Malaysia,
Thailand, Vietnam, China
URL <https://www.exercorp.com>
Mail sales@exercorp.com

Megagoal Pte Ltd.
Sales Office: Singapore, India
URL <https://www.megagoal.com>
Mail enquiry@megagoal.com

SUN-WA TECHNOS PTE LTD.
Sales Office: : Singapore, Malaysia,
Thailand, Vietnam, China
URL <https://www.sunwa.co.jp/about/company/oversea/index.html>

Arrow Electronics Asia Pte Ltd.
Sales Office: Singapore, Malaysia,
Thailand, Vietnam, China
URL: <https://www.arrow.com/>

KANADEN CORPORATION
Sales Office: Singapore, Thailand
URL <https://www.kanaden.co.jp/en/corporate/network/>

Chip One Stop, Inc.
Sales office : Yokohama city, Japan
URL <https://www.chip1stop.com/maker/pick-up?makerCd=SSM1>

Kuroda Electric Co., Ltd.
Sales office: Singapore, Indonesia, Malaysia,
Thailand, Vietnam, Philipines, Taiwan,
India, Korea
URL <https://www.kuroda-electric.co.jp/english/profile/oversea>

CHINA

SUSUMU INTERNATIONAL TRADING (SHANGHAI) CO., LTD.
Head office:Room422, 3U Building, 8 Huajing Road,
Pilot Free Trade Zone, Shanghai City
200131,P.R.C
TEL +86-21-5046-4992
FAX +86-21-5046-4993
Puxi Branch:Room1001F, Magnolia International Plaza,
777 Hongqiao Road,ShanghaiCity 200030,P.R.C
URL <http://www.susumu.sh.cn/>
Mail susumu@susumu.sh.cn

Ameya Holding Limited
Office Shanghai, Shenzhen
URL <http://www.ameya360.com>
Mail service@ameya360.com

Elematec Trading Co.,Ltd.
Office Shanghai, Nanjing, Wuxi, Suzhou,
Hangzhou, Shenzhen, Changsha,
Xiamen, Canton, Zhuhai, Hong Kong
URL <http://www.elematec.com/en/info/map/overseas/>

KANADEN CORPORATION LTD.
Office Shanghai
URL <https://www.kanaden.co.jp/en/corporate/network/>

SINGAPORE

SUSUMU SINGAPORE PTE.LTD.
629 Aljunied Road #03-20, Cititech Industrial
Building,
Singapore, 389838
TEL +65-6741-4070 FAX +65-6741-2971
URL <http://www.susumu.sg/>
Mail ssm-sg@susumu.co.jp

Future Electronics Inc
URL <http://www.futureelectronics.com>

INDIA

Rabyte Technologies LLP
URL <http://www.rabyte.com>

O S Electronics India Pvt. Ltd.
URL https://www.oselec.jp/location/list_overseas.htm

KOREA

Alliedchips Korea Co., Ltd.
URL <http://www.alliedchips.co.kr>
Mail master@alliedchips.co.kr

Gillanix Corporation
URL <http://www.gillanix.com/>
Mail jeff.youn@gillanix.com

SAMYOUNG S&C Co., Ltd.
URL <http://www.samyongsnc.com/>
Mail sales@samyongsnc.com

mo.in Co., Ltd.
Mail moinandy99@gmail.com

NEXTRON KOREA CO.,LTD.
URL <http://nextronkorea.com/eng/>
Mail jacob@nextronkorea.com

TAIWAN

CYNTEC CO., LTD.
URL <http://www.cyntec.com>
Mail service@cyntec.com

Multicom Technology LTD.
URL <https://www.multicom.com.tw/>
Mail sales@multicom.com.tw

Walter Electronic CO. LTD.
URL <http://www.walterfuse.com>
Mail walter@walterfuse.com

HONGKONG

KANADEN CORPORATION (H.K.) LTD.
URL <https://www.kanaden.co.jp/en/corporate/network/>

Willas-Array Electronics(Hong Kong)Ltd.
URL <http://www.willas-array.com>
Mail wae@willas-array.com(Hong Kong Headquarter)

Z. KURODA (HONGKONG) CO., LTD.
URL <https://www.kuroda-electric.co.jp/english/profile/oversea>

Suzhou Industrial Park JingDian Electronics Co.,Ltd
URL <http://www.simon-jd.com>
Mail service@simon-jd.com

Suzhou Walter Electronic Co.,Ltd
URL <http://www.walterfuse.com>
Mail bs.ang@walterfuse.cn

Willas-Array Electronics Limited
URL <http://www.willas-array.com>
Mail arc-sales@willas-array.com
(Shanghai - Northern China Sales Offices)
Mail sac-sales@willas-array.com
(Shenzhen- Southern China Sales Offices)

Xiamen Holder Electronics Co., Ltd. Sino Faith Technology Development Ltd.
URL <http://www.xmholder.com/index.aspx>
Mail xmholder@xmholder.com

SHANGHAI KURODA MANAGEMENT CO., LTD
Office Shanghai, Tianjin, Nanjing, Shenzhen
URL <https://www.kuroda-electric.co.jp/english/profile/oversea>

Sales offices - NORTH AMERICA -

North America

Digi-Key Corporation

URL <http://www.digikey.com>

Future Electronics Inc.

URL <http://www.futureelectronics.com>

America II

URL <http://www.americaii.com>

SPIRIT ELECTRONICS

URL <https://www.spiritelectronics.com/>
Mail info@spiritelectronics.com

SUSUMU INTERNATIONAL(USA) INC. East Coast Office(HQ)

460 Bergen Blvd., Suite 226, Palisades Park, NJ 07650 USA
TEL +1-201-461-4861 FAX +1-201-461-4862
URL <http://www.susumu-usa.com/>
Mail info@susumu-usa.com

SUSUMU INTERNATIONAL(USA) INC. West Coast Office

4100 Moorpark Ave., Suite 206, San Jose, CA 95117 USA
TEL +1-408-260-1112 FAX +1-408-260-1113
Mail tech@susumu-usa.com

SUSUMU INTERNATIONAL(USA) INC. North Branch Office

1546 Tower Blvd., North Mankato, MN 56003 USA
TEL +1-507-369-3498
Mail tech@susumu-usa.com

Newark element14

URL <http://www.newark.com>

Mouser Electronics, Inc.

URL <http://www.mouser.com>

Arrow Electronics

URL <http://www.arrow.com>
Mail websupport@arrow.com

KURODA ELECTRIC U.S.A. INC.

Sales office : Michigan, Santa Clara, Tennessee,
San Diego, Mexico
URL <https://www.kuroda-electric.co.jp/english/profile/oversea>

Rutronik Inc.

URL <https://www.rutronik.com>
Mail Sales-na@rutronik.com

Sales offices - EUROPE • MIDDLE EAST -

GERMANY

SUSUMU DEUTSCHLAND GmbH

Frankfurter Strasse 63-69, 7th Floor, D-65760,
Eschborn / Germany
TEL +49-6196-969-8407
FAX +49-6196-969-8879
URL <http://www.susumu.de/>
Mail info@susumu.co.jp

Endrich Bauelemente Vertriebs GmbH

URL <http://www.endrich.com/>
Mail endrich@endrich.com

Gudeco Elektronik Handelsgesellschaft mbH

URL <http://www.gudeco.de/>
Mail info@gudeco.de

Rutronik Elektronische Bauelemente GmbH

URL <http://www.rutronik.com>
Mail rutronik@rutronik.com

WDI AG

URL <http://www.wdi.ag>
Mail info@wdi.ag

Arrow Central Europe GmbH

URL <http://www.arroweurope.com/>
Mail websupport@arrow.com

FRANCE

Manudax France

URL <http://www.manudax.fr/>
Mail manudax@manudax.fr

CZECH REPUBLIC

Has Lanskrout GmbH

URL <http://www.hasdc.cz/>
Mail sekretariat@hasdc.cz

NETHERLANDS

Batenburg Mechatronica

URL <https://batenburg-mechatronica.nl/>
Mail info.mechatronica@batenburg.nl

DENMARK

Rhopoint Nordic Aps.

URL <http://www.rhopointnordic.com/>
Mail sales@rhopointnordic.com

BELGIUM

Batenburg Mechatronica

URL <https://batenburg-mechatronica.nl/>
Mail sales-me@batenburgbelgie.be

Sales offices - EUROPE · MIDDLE EAST -

■ AUSTRIA

■ Endrich Ges.m.b.H
 URL <http://www.endrich.com/>
 Mail austria@endrich.com

■ ROMANIA

■ Endrich Bauelemente Vertriebs GmbH
 office Timisoara
 URL <http://www.endrich.com>
 Mail romania@endrich.com

■ SWITZERLAND

■ Stolz Electronics AG
 URL <http://www.stolzelectronics.ch/>
 Mail info@stolzelectronics.ch

■ FINLAND

■ Elgood Oy
 URL <https://www.elgood.fi/>
 Mail sales@elgood.fi

■ HUNGARY

■ Endrich Bauelemente Vertriebs GmbH
 office Budapest
 URL <http://www.endrich.com/>
 Mail hungary@endrich.com

■ BULGARIA

■ Endrich Bauelemente Vertriebs GmbH
 office Sofia
 URL <http://www.endrich.com/>
 Mail bulgaria@endrich.com

■ UNITED KINGDOM

■ Rhopoint Components, Ltd.
 URL <http://www.rhopointcomponents.com>
 Mail sales@rhopointcomponents.com

■ Profusion plc

URL <http://www.profusionplc.com>
 Mail sales@profusion.email

■ RS Components K.K

URL <http://uk.rs-online.com/web/>

■ SPAIN

■ Endrich Bauelemente Vertriebs GmbH
 office Barcelona
 URL <http://www.endrich.com/>
 Mail spain@endrich.com

■ ISRAEL

■ BORAN TECHNOLOGIES LTD.
 URL <http://www.boran.co.il>
 Mail support@boran.co.il

SUSUMU CO., LTD.

JAPAN

SUSUMU CO., LTD. Headquarters

14 Umamawashi-Cho Kamitoba, Minami-Ku Kyoto, 601-8177 Japan
TEL +81-75-671-7371 FAX +81-75-671-7374 URL <https://www.susumu.co.jp/> Mail : info@susumu.co.jp

<https://www.susumu.co.jp/english/>

GERMANY

SUSUMU DEUTSCHLAND GmbH

Frankfurter Strasse 63-69, 7th Floor, D-65760, Eschborn, Germany
TEL +49-6196-969-8407 FAX +49-6196-969-8879 URL <http://www.susumu.de/> Mail : info@susumu.de

U.S.A

SUSUMU INTERNATIONAL(USA) INC. East Coast Office(H.Q.)

460 Bergen Blvd., Suite 226, Palisades Park, NJ, 07650, USA
TEL +1-201-461-4861 FAX +1-201-461-4862 URL <http://www.susumu-usa.com/> Mail : info@susumu-usa.com

CHINA

SUSUMU INTERNATIONAL TRADING (SHANGHAI) CO., LTD.

Room422, 3U Building, 8 Huajing Road, Pilot Free Trade Zone, Shanghai City P.R.C, 200131
TEL +86-21-5046-4992 FAX +86-21-5046-4993 URL <http://www.susumu.sh.cn/> Mail : susumu@susumu.sh.cn

SINGAPORE

SUSUMU SINGAPORE PTE.LTD.

629 Aljunied Road #03-20, Cititech Industrial Building, Singapore, 389838
TEL +65-6741-4070 FAX +65-6741-2971 URL <http://www.susumu.sg/> Mail : ssm-sg@susumu.co.jp

KOREA

SUSUMU KOREA CO., LTD.

A-1022, Doosan The Landpark, 161-8, Magokjungang-ro, Gangseo-gu, Seoul, Republic of Korea
TEL +82-2-6989-8721 URL <https://www.susumu.co.kr/> Mail : info@susumu.co.kr